

HUDSON VALLEY LIGHTING GROUP

Hudson Valley Lighting | Troy Lighting | Mitzi | Corbett Lighting

WARNING/CAUTION

- DISCONNECT POWER BEFORE RE-LAMPING OR WIRING THE FIXTURE. READ ALL INSTRUCTIONS COMPLETELY BEFORE STARTING INSTALLATION.
- TO AVOID THE RISK OF FIRE OR SHOCK, FIXTURE MUST BE INSTALLED IN COMPLIANCE WITH ALL APPLICABLE NATIONAL AND LOCAL ELECTRICAL/BUILDING CODES. THE INSTALLATION AND MAINTENANCE OF THIS UNIT SHOULD BE COMPLETED BY A LICENSED ELECTRICIAN OR CERTIFIED FACTORY TRAINED TECHNICIAN.
- CALIFORNIA PROP 65: THIS LIGHTING FIXTURE CONTAINS CHEMICALS KNOWN TO THE STATE OF CALIFORNIA TO CAUSE CANCER, BIRTH DEFECTS, AND/OR OTHER REPRODUCTIVE HARM. WASH HANDS AFTER USE.
- UNPACK FIXTURE, PARTS AND PARTS BAG(S) BEFORE DISCARDING THE CARTON. MAKE CERTAIN THAT ALL PARTS ARE FOUND. INSPECT THE FIXTURE PRIOR TO INSTALLATION FOR ANY DAMAGE. HVLG DOES NOT PAY OR REIMBURSE ELECTRICIAN FEES. FIXTURE MAY NOT BE RETURNED ONCE IT HAS BEEN INSTALLED. SEE WARRANTY FOR EXCEPTIONS.
- PLEASE CLEAN WITH A SOFT, DRY CLOTH ONLY! DO NOT USE CLEANSERS.

ATTENTION PRUDENCE

- DÉBRANCHEZ L'ALIMENTATION AVANT DE REMPLIR OU DE CÂBLER LE LUMINAIRE. LISEZ COMPLÈTEMENT TOUTES LES INSTRUCTIONS AVANT DE COMMENCER L'INSTALLATION
- POUR ÉVITER LE RISQUE D'INCENDIE OU D'ÉLECTROCUTION, LE LUMINAIRE DOIT ÊTRE INSTALLÉ CONFORMÉMENT À TOUS LES CODES ÉLECTRIQUES/DE CONSTRUCTION NATIONAUX ET LOCAUX APPLICABLES. L'INSTALLATION ET L'ENTRETIEN DE CET APPAREIL DOIVENT ÊTRE EFFECTUÉS PAR UN ÉLECTRICIEN AGRÉÉ OU UN TECHNICIEN CERTIFIÉ FORMÉ EN USINE.
- CALIFORNIE PROP 65 : CET APPAREIL D'ÉCLAIRAGE CONTIENT DES PRODUITS CHIMIQUES CONNUS PAR L'ÉTAT DE CALIFORNIE POUR PROVOQUER LE CANCER, DES MALADIES CONGÉNITALES ET/OU D'AUTRES DOMMAGES À LA REPRODUCTION. LAVER LES MAINS APRÈS UTILISATION.
- DÉBALLEZ LE LUMINAIRE, LES PIÈCES ET LE(S) SAC(S) DE PIÈCES. AVANT DE JETER LE CARTON. ASSUREZ-VOUS QUE TOUTES LES PIÈCES SONT TROUVÉES. INSPECTEZ LE LUMINAIRE AVANT DE L'INSTALLER POUR DÉTECTER TOUT DOMMAGE. HVLG NE PAIE NI NE REMBOURSE LES FRAIS D'ÉLECTRICITÉ. LE LUMINAIRE NE PEUT PAS ÊTRE RETOURNÉ UNE FOIS QU'IL A ÉTÉ INSTALLÉ. VOIR GARANTIE POUR LES EXCEPTIONS.
- VEUILLEZ NETTOYER UNIQUEMENT AVEC UN CHIFFON DOUX ET SEC ! N'UTILISEZ PAS DE NETTOYANTS.

PRECAUCIÓN ADVERTENCIA

- DESCONECTE LA CORRIENTE ANTES DE VOLVER A ENCENDER O CONECTAR EL APARATO. LEA TODAS LAS INSTRUCCIONES ANTES DE COMENZAR LA INSTALACIÓN.
- PARA EVITAR EL RIESGO DE INCENDIO O DESCARGA ELÉCTRICA, LA INSTALACIÓN DEBE SER REALIZADA DE CONFORMIDAD CON TODOS LOS CÓDIGOS DE CONSTRUCCIÓN / ELÉCTRICOS NACIONALES Y LOCALES APPLICABLES. LA INSTALACIÓN Y EL MANTENIMIENTO DE ESTA UNIDAD DEBE SER REALIZADO POR UN ELECTRICISTA LICENCIADO O UN TÉCNICO CAPACITADO POR UNA EN FÁBRICA CERTIFICADORA.
- CALIFORNIA PROP 65: ESTE APARATO DE ILUMINACIÓN CONTIENE PRODUCTOS QUÍMICOS QUE EL ESTADO DE CALIFORNIA SE CONOCE POR CAUSAR CÁNCER, DEFECTOS DE NACIMIENTO Y / U OTROS DAÑOS REPRODUCTIVOS. LAVARSE LAS MANOS DESPUÉS DEL USO.
- DESEMBALA LOS ACCESORIOS, REPUESTOS Y BOLSA (S) DE REPUESTOS. ANTES DE DESECHAR LA CAJA. ASEGÚRESE DE ENCONTRAR TODAS LAS PIEZAS. INSPECCIONE EL ACCESORIO ANTES DE LA INSTALACIÓN POR CUALQUIER DAÑO. HVLG NO PAGA NI REEMBOLSA LAS TARIFAS DEL ELECTRICISTA. EL ACCESORIO NO SE PUEDE DEVOLVER UNA VEZ QUE SE HAYA INSTALADO. CONSULTE LA GARANTÍA PARA EXCEPCIONES.
- ¡LIMPIE CON UN PAÑO SECO Y SUAVE ÚNICAMENTE! NO USE LIMPIADORES.

FIXTURE INSTALLATION

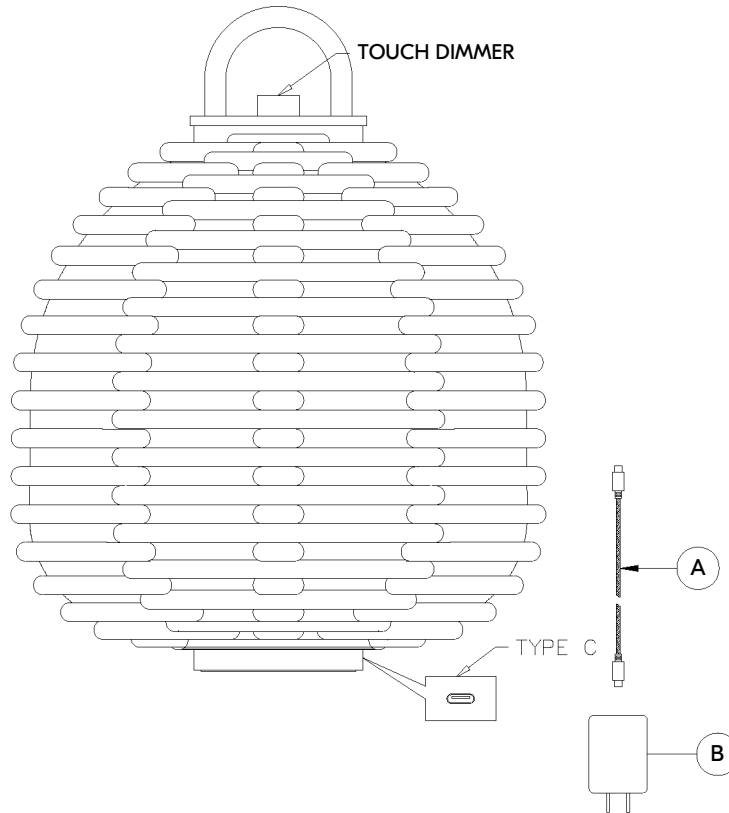

Input Rating: 5Vdc,Max.2A.
Led Power: 3W
Battery: Lithium-ion,3.7Vdc,5000mAh

- Carefully remove the fixture from its packaging and connect it using the provided USB-C CABLE (A) and WALL CHARGER (B). Make sure the product is fully charged before its first use.
 - Solid Red: Fixture is charging.
 - Solid Green: Fixture is fully charged.
- Tap the TOUCH DIMMER of the lamp to turn the fixture on and off. Touch and hold to dim and adjust the brightness.
- Battery disposal should be in compliance with any local regulations that address the disposal of hazardous materials. Do not incinerate.
- This device complies with Part 15 of the FCC Rules. Operation is subject to the following two conditions:
 - This device may not cause harmful interference.
 - This device must accept any interference received, including interference that may cause undesired operation.
- Changes or modifications not expressly approved by the party responsible for compliance could void the user's authority to operate the equipment.

This equipment has been tested and found to comply with the limits for a Class B digital device, pursuant to part 15 of the FCC Rules. These limits are designed to provide reasonable protection against harmful interference in a residential installation. This equipment generates, uses and can radiate radio frequency energy and, if not installed and used in accordance with the instructions, may cause harmful interference to radio communications. However, there is no guarantee that interference will not occur in a particular installation. If this equipment does cause harmful interference to radio or television reception, which can be determined by turning the equipment off and on, the user is encouraged to try to correct the interference by one or more of the following measures:

- Reorient or relocate the receiving antenna.
 - Increase the separation between the equipment and receiver.
 - Connect the equipment into an outlet on a circuit different from that to which the receiver is connected.
 - Consult the dealer or an experienced radio/ TV technician for help.
- CAN ICES-005 (B) / NMB-005 (B)

FIXTURE INSTALLATION

1. Drill the appropriate size holes for the WALL ANCHORS (A). (the holes should be slightly smaller than the size of the anchors.) Install the WALL ANCHORS (A) to the hole.
2. Use WOOD SCREW (B) to fix the BRACKET (C) to the wall. Then hang the FIXTURE ASSEMBLY on the BRACKET (C).

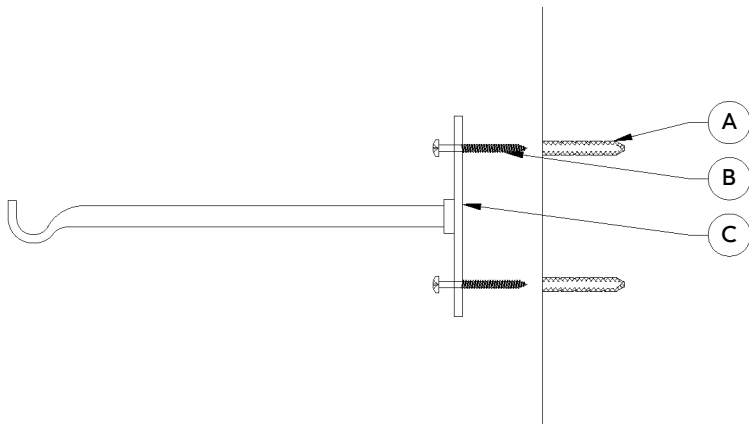

PART(S)	REPLACEMENT PART NAME	NUMBER
A,B,C	HARDWARE KIT	HDW-B8604