

2014 - Aries 25" Round LED Pendant

Constellation®

assembly instructions

Constellation[®] Product Information and Warnings

Important

- **Always disconnect the power before installing or replacing Luminaires and before cleaning or other maintenance.**
- **Consult a qualified, licensed electrician to ensure correct branch circuit conductor.**
Consulter un électricien qualifié pour vous assurer que les conducteurs de la dérivation sont adéquats.
- Please read all included assembly instructions and warnings carefully before installation. Contact Customer Service if you have any questions or concerns. Before installation, please confirm that the fixture is compatible with your supply voltage and dimming system, if present.
- LEDs are highly sensitive electronic devices, and must be treated with care. Do not open any factory sealed compartments, and avoid touching the LEDs with your hands or any object.
- Although all our fixtures are equipped with protective devices, LED electronic systems are vulnerable to power surges and supply variations. Do not install LED fixtures on the same circuit as any motors, appliances, or HVAC systems.
- Remote LED Driver installation must be done by a licensed electrician and in accordance with local building and electrical codes. Remote installations should be in an accessible location, as close to the fixture as possible. The appropriate wire gauge must be used to limit the voltage drop to avoid overloading the LED Driver.
- Any mounting hardware is provided for your convenience and should be used with discretion. Always use the appropriate hardware for the mounting surface.
- Constellation LED Drivers are 24VDC Constant Voltage output.
- Constellation must be installed in dry locations ONLY.

Welcome to Constellation[®]

A Constellation configuration is built from LED hubs, connecting arms, end arms, and cable ceiling hangers. Illumination radiates through either the white optical acrylic lenses, or sparkles with refracted light through micro-faceted clear acrylic crystal lenses. Each hub is a complete LED light engine, using an array of LEDs with driver circuitry on each of the two faces of the hub. The connecting arms form a structural and electrical connection between the hubs, and are easily assembled by inserting the arm into the hub and are secured in place by a retaining set screw. The hubs can revolve around the connecting arms to alter the orientation of the illumination and that of the intersecting connecting arms. The configuration is supported by cable bushings in the canopy and is powered by a special power feed installed into the hubs connected to the ceiling power feed.

WHAT COMES IN THE BOX

Power Feed and Supply

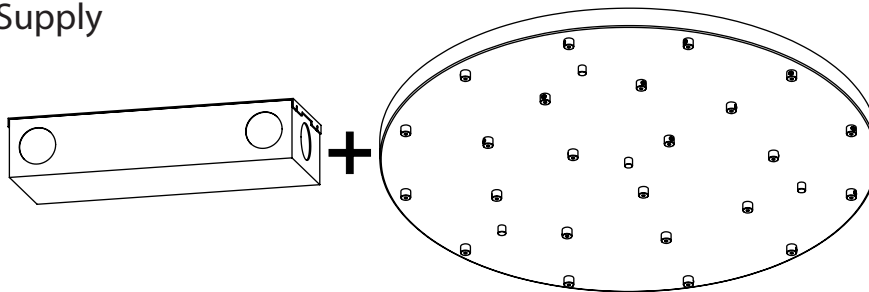

Remote Power Supply w/ Canopy
(Qty 1)

Power Feed Hardware

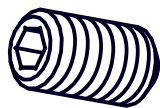

Canopy Set Screw
(Qty 24+)

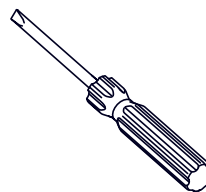

Screwdriver
(Qty 1+)

Hubs and Power Feed Hangers

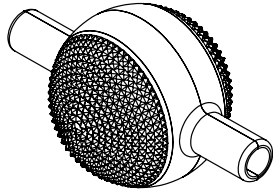

Linear Hub
(Qty 48)

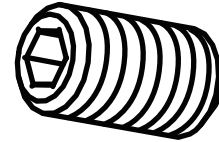

M2 Set Screw
(Qty 96+)



Cord Power Feed Hanger
(Qty 24)

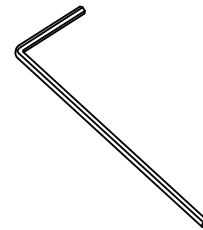

Small Hex Wrench
(Qty 1+)

Arm Info

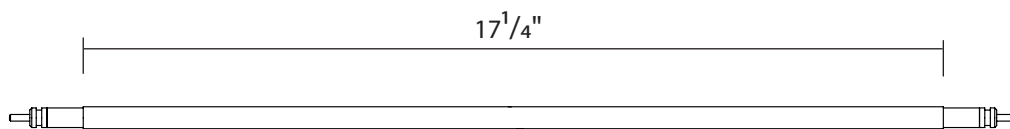

Connecting Arm

Connecting Arms	
Arm #	Qty
17 1/4" Connecting Arm	24

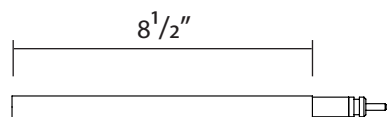

End Arm

End Arms	
System #	Qty
8 1/2" End Arm	24

Installation Instructions

1. Shut off power to the Outlet Box (A).
2. Install the Power Supply (B) in a remote and accessible location near the fixture in accordance with local electrical code. Make appropriate electrical connections using wire nuts:
 - a. Connect the Power Supply's live wire (black) to the live supply wire.
 - b. Connect the Power Supply's neutral wire (white) to the neutral supply wire.
 - c. Connect the Power Supply's ground wire (green or uncoated) to the ground supply wire.
 - d. Connect the Power Supply's positive (+) output wire (red) to the required length of red wire (not included) to reach the Outlet Box (A).
 - e. Connect the Power Supply's negative (-) output wire (black) to the required length of black wire (not included) to reach the Outlet Box (A).
3. Insert the Cord Power Feed Hanger (C) through the Bushing (E) on the Canopy (K). Adjust the Cord length as desired, and secure with the Slotted Set Screw (F) using the provided Screwdriver (G).
4. Using the wiring diagram and instructions in appendix B, connect the Cord Power Feed Hangers (C) to the Lever Nuts (R). Reserve extra Cord and Lever Nut assembly in the Canopy (K). If shortening of the cords is necessary, refer to appendix A.
5. Attach mounting plate (H) to the outlet box (A), secure with outlet box screws (J). Use appropriate screws to secure the mounting plate into the ceiling.

CAUTION: Fixture must be supported independent of outlet box. Customer is responsible for ensuring appropriate ceiling construction to support the weight of the fixture.
6. Screw Safety Cables (U) from Canopy to Studs (V) on Mounting Plate (H).
7. Make appropriate electrical connections to the lever nuts:
 - a. Connect the positive (red) low voltage wire from the Power Supply (B) to the red side (inner, jacketed conductor) of the Power Feed Hangers (C).
 - b. Connect the negative (black) low voltage wire from the Power Supply (B) to the black side (outer, braided conductor) of the Power Feed Hangers (C).
8. Install the Canopy (K) to the Mounting Plate (H) and secure with Finials (L).
9. Assemble strands per page 6.
10. Restore power.

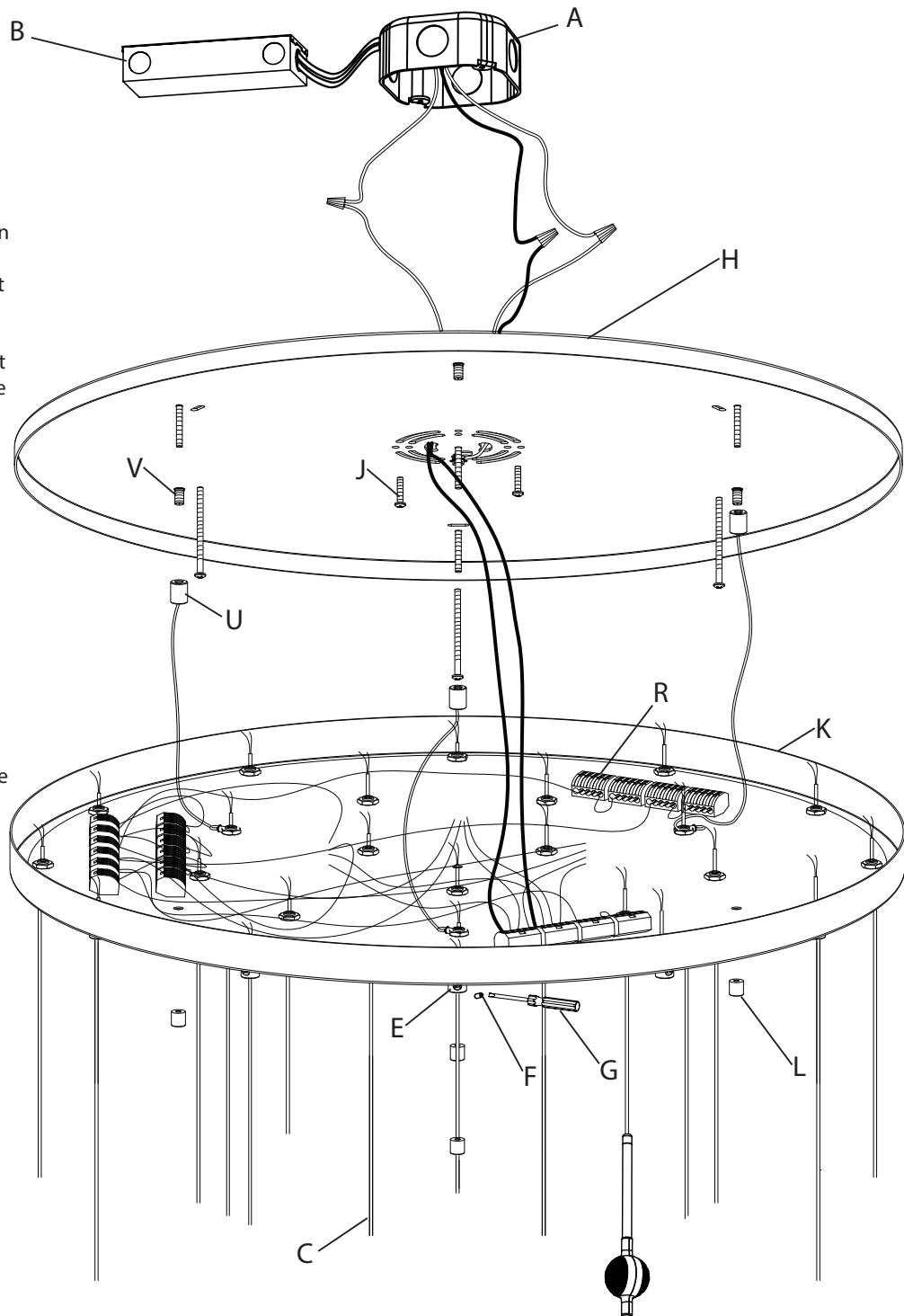

Fig. 1

Arm and LED Hub Section Assembly:

Attach a Linear Hub (D) to the end of each Cord Power Feed Hanger (M) by fully inserting into a Neck (N) on the Hub (Fig. 2). Install the M2 Set Screw (P), using the Small Hex Wrench (Q) provided, and tighten until it comes in contact with the plastic cap on the Hanger. Use the diagram (Fig. 3) and the following page for installation pattern. **CAUTION: Do not over tighten the set screws.**

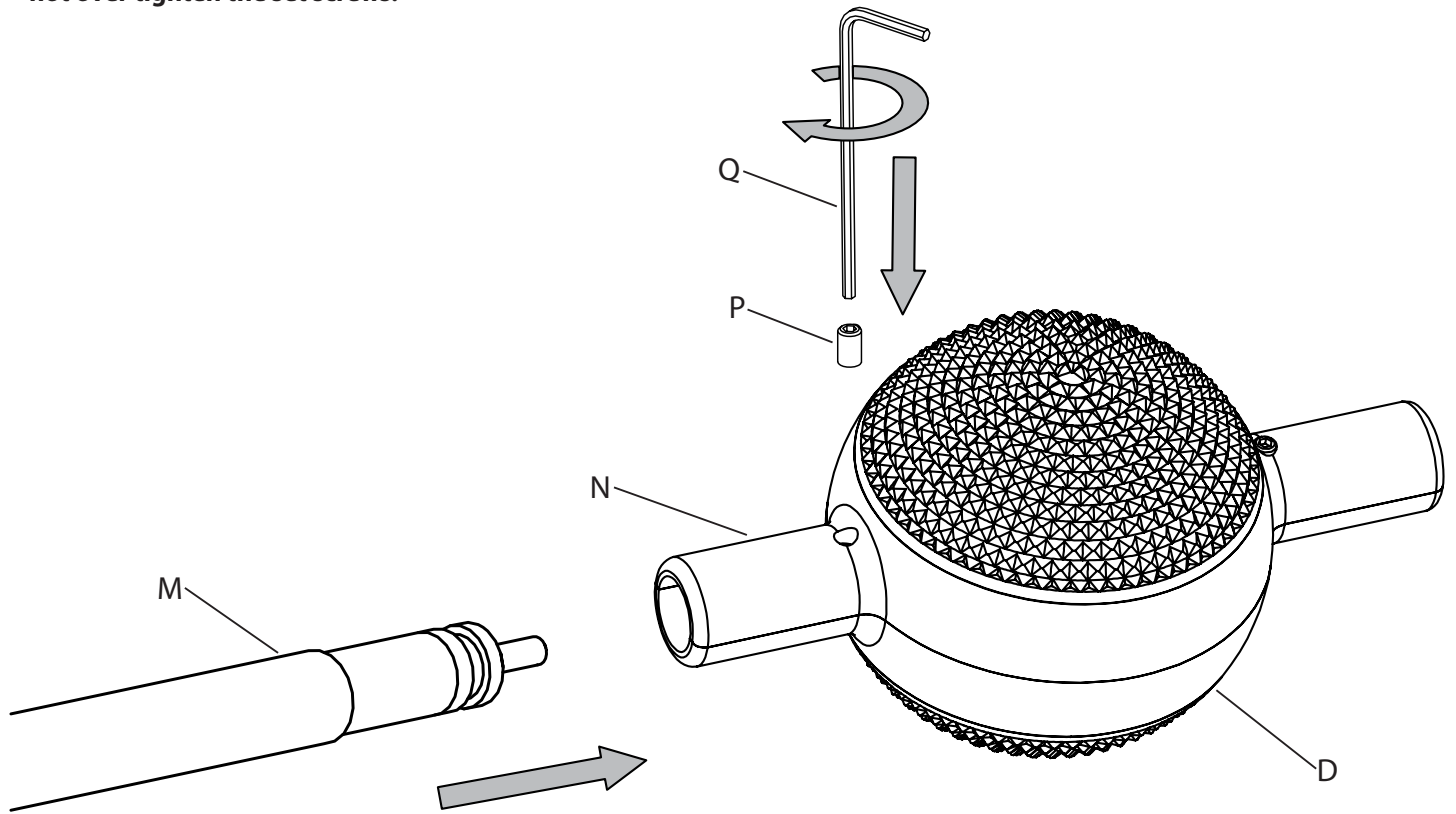

Fig. 2

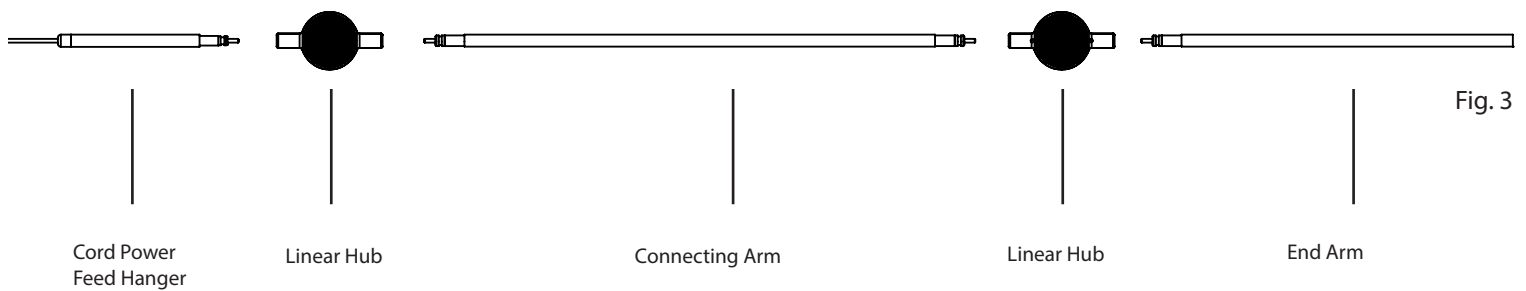

Fig. 3

Coax Splicing

Assembly Instructions

INSTRUCTIONS D'INSTALLATION

FAILURE TO FOLLOW THESE INSTRUCTIONS WILL VOID THE WARRANTY

Coaxial Power Cord:

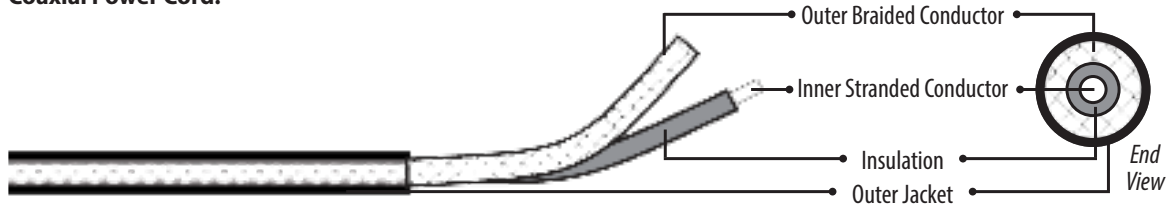

If field-cutting is required, please follow the below instructions:

1. Make a 1" slice along the length of the cord's outer jacket (Fig. 1). **CAUTION: Do not cut through the outer braided conductor.**
2. Carefully strip the outer jacket of the cord and keep the outer braided conductors intact (Fig. 1).
3. Slide the outer braided conductor back to create a bulge and reveal the inner stranded conductor (Fig. 2).
4. Bend the cord to create an opening through the bunched-up portion of outer braided conductor, then pull out the inner stranded conductor (Fig. 3)
5. Twist together the outer braided conductor to form the negative wire of the fixture, then strip 5/8" off the end of the inner stranded conductor to form the positive wire of the fixture (Fig. 4).
6. Re-splice all power cords.

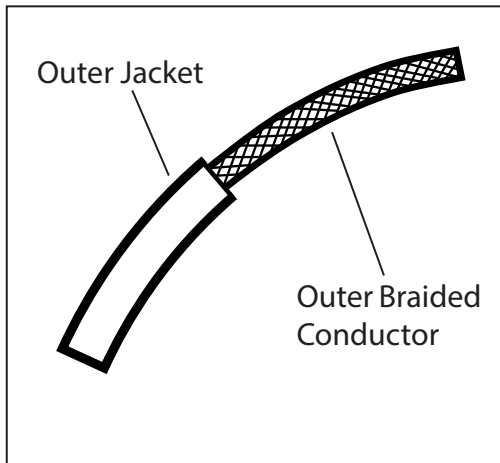

Fig. 1

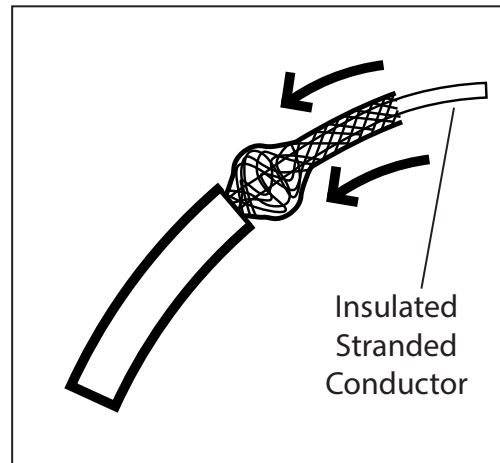

Fig. 2

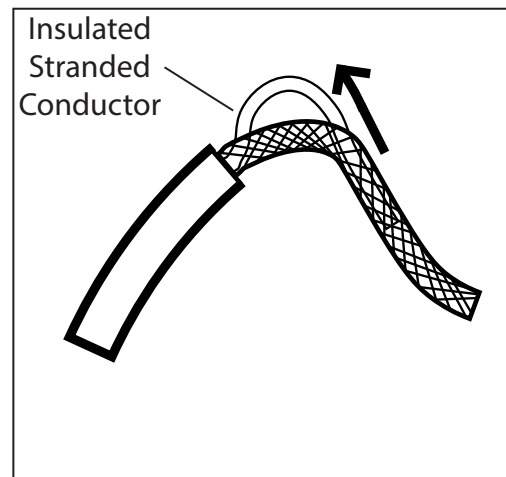

Fig. 3

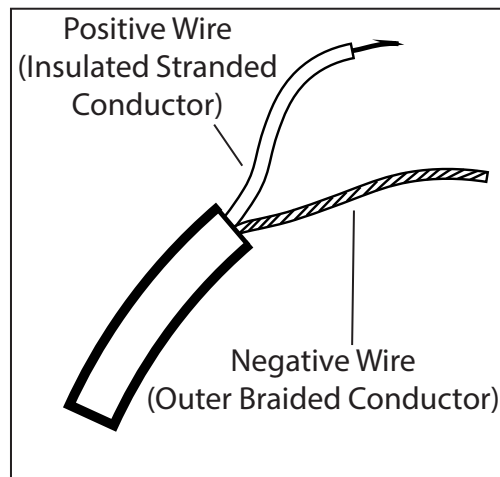
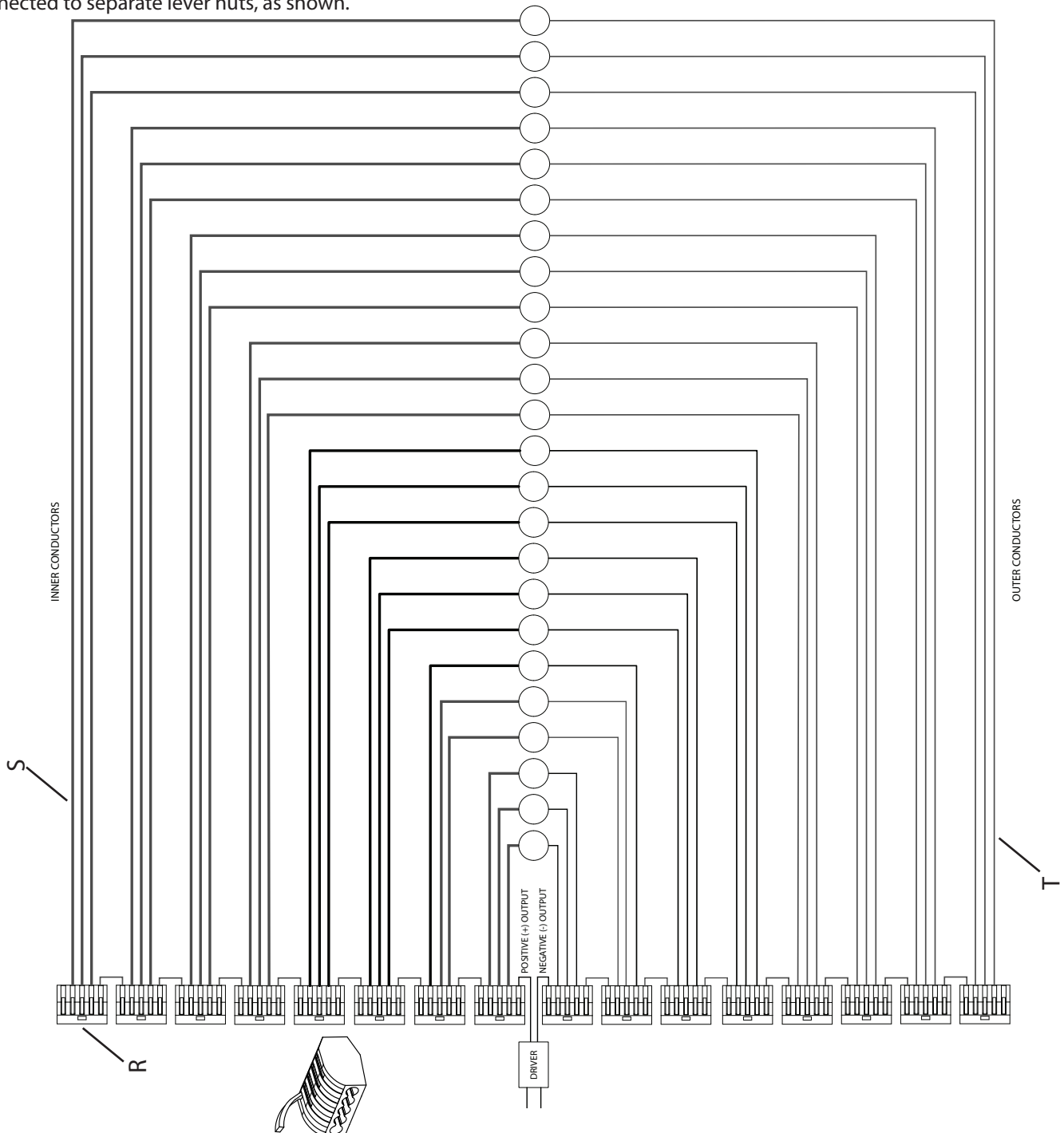

Fig. 4

Wiring Diagram

Connect the fixture wires to the lever nuts (R) by pulling up on the lever for an empty slot, inserting the wire, and pushing the lever back down to lock. The inner stranded (red) conductor (S) and outer braided (black) conductor (T) on each cord must be connected to separate lever nuts, as shown.



Note

- See markings on LED Driver for compatible dimmer types.

Care Instructions

- **Dusting:** Use a clean, dry cloth.
- **Cleaning:** To protect the finish, avoid any harsh abrasives or chemicals.