

**TOOLS NEEDED (NOT INCLUDED):**



Phillips-head screwdriver



Pencil



Stud Finder

**INCLUDED TOOLS + HARDWARE:**



A - Screws (x3)  
8 x 30mm

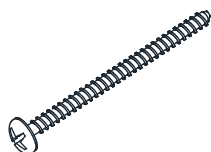

B - Screws (x3)  
8 x 55mm

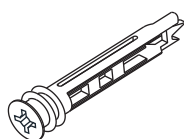

C - Drywall Anchors (x3)

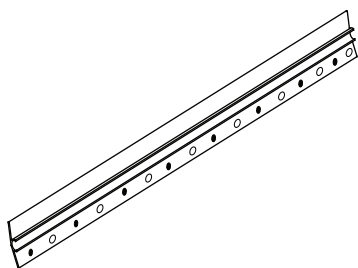

D - Wall Bracket (x1)  
400 x 36.5 x 7 x 1.5mm



E - Bubble Level (x1)  
Ø8 x 22mm

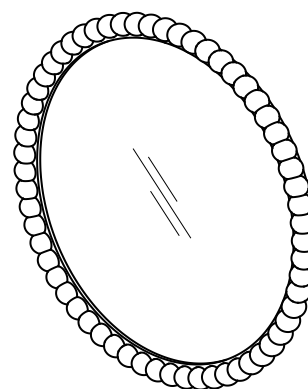

F - Round Mirror (x1)

**SAFETY INSTRUCTIONS:**

- These instructions are provided for your safety.
- It is important that they are read carefully and completely before installation of the fixture.
- Professional installation is strongly recommended.
- For your safety, it is recommended that two people hang the fixture.
- Check with a professional to ensure your wall can tolerate fixture weighing 47 lbs.
- For optimal stability we recommend mounting to a wall stud.

**Note:**

Supplied mounting hardware is for typical drywall and wooden wall construction. For other wall materials, please consult your local independent hardware store.

## ASSEMBLY INSTRUCTIONS

- Carefully remove all parts from the box, and remove all plastic coverings.
- Place the Bubble Level (E) into the groove of the Wall Bracket (D) to test and make sure the wall bracket is level. Use the pencil to mark the holes' positions on the wall.

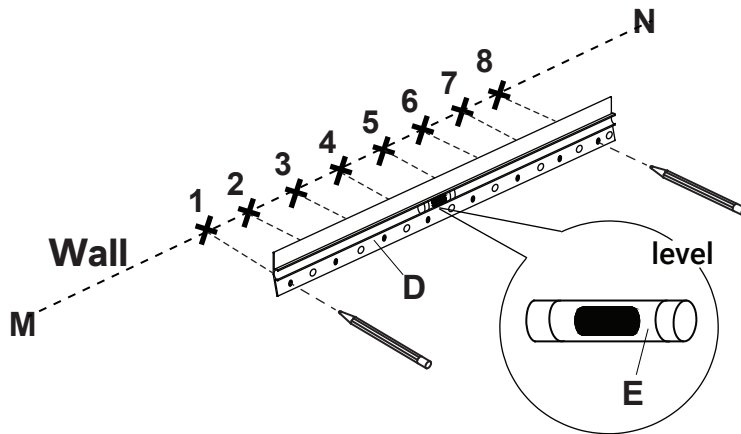

- Use the stud-finder to determine if there are wall studs located at the marked locations. Install the appropriate hardware, as shown below.
- Place the Wall Bracket (D) horizontally against the wall at the marked points, then use appropriate hardware to secure the bracket to the wall.

**NOTE:** Prioritize to use Drywall Anchors (C) and long screws (B) for the mounting positions on the outermost side of the Wall Bracket (D).

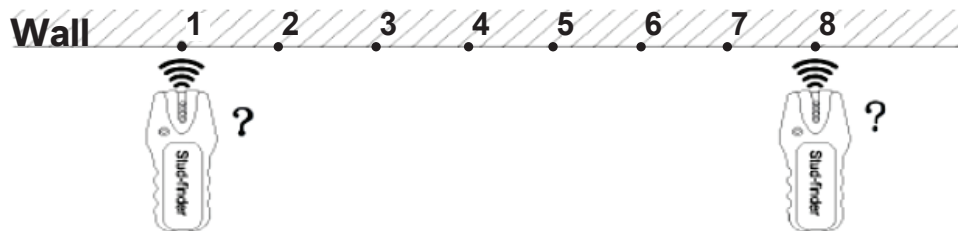

### For stud mounting:

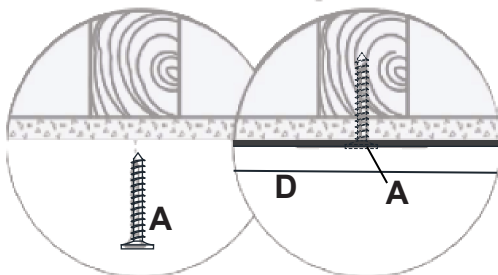

### For non-stud mounting:

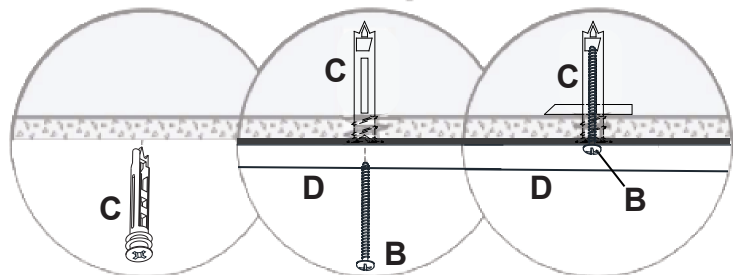

**Tips:**  
 The anchor is self-drillable.  
 No pilot hole required.

TO INSTALL MIRROR:

5. Finally, carefully place the Mirror slide the back panel bracket onto the Wall Bracket (D).

