

### TOOLS NEEDED (NOT INCLUDED):

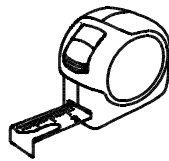

Stud Finder



Tape Measure

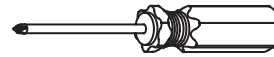

Phillips-head screwdriver



Pencil

### INCLUDED TOOLS + HARDWARE:



A - Long Screws (x4)  
M4 x 30mm



B - Short Screws (x4)  
M4 x 20mm

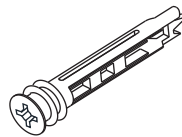

C - Drywall Anchors (x3)

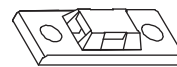

D - Plastic Brackets (x4)



E - Restraint Strap (x2)

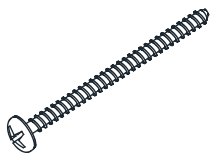

F - Screws (x3)  
8 x 55mm

G - Floor Mirror (x1)

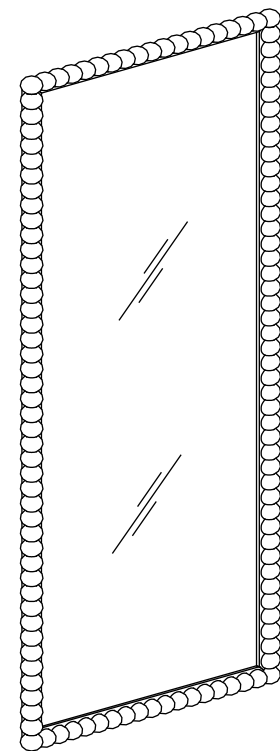

### SAFETY INSTRUCTIONS:

- These instructions are provided for your safety.
- It is important that they are read carefully and completely before installation of the fixture.
- Professional installation is strongly recommended.
- For your safety, it is recommended that two people hang the fixture.
- Check with a professional to ensure your wall can tolerate fixture weighing 47 lbs.
- For optimal stability we recommend mounting to a wall stud.

#### Note:

Supplied mounting hardware is for typical drywall and wooden wall construction. For other wall materials, please consult your local independent hardware store.

## ASSEMBLY INSTRUCTIONS

### Mounting Instructions:

1. Measure the distance between the center of the two Keyholes.

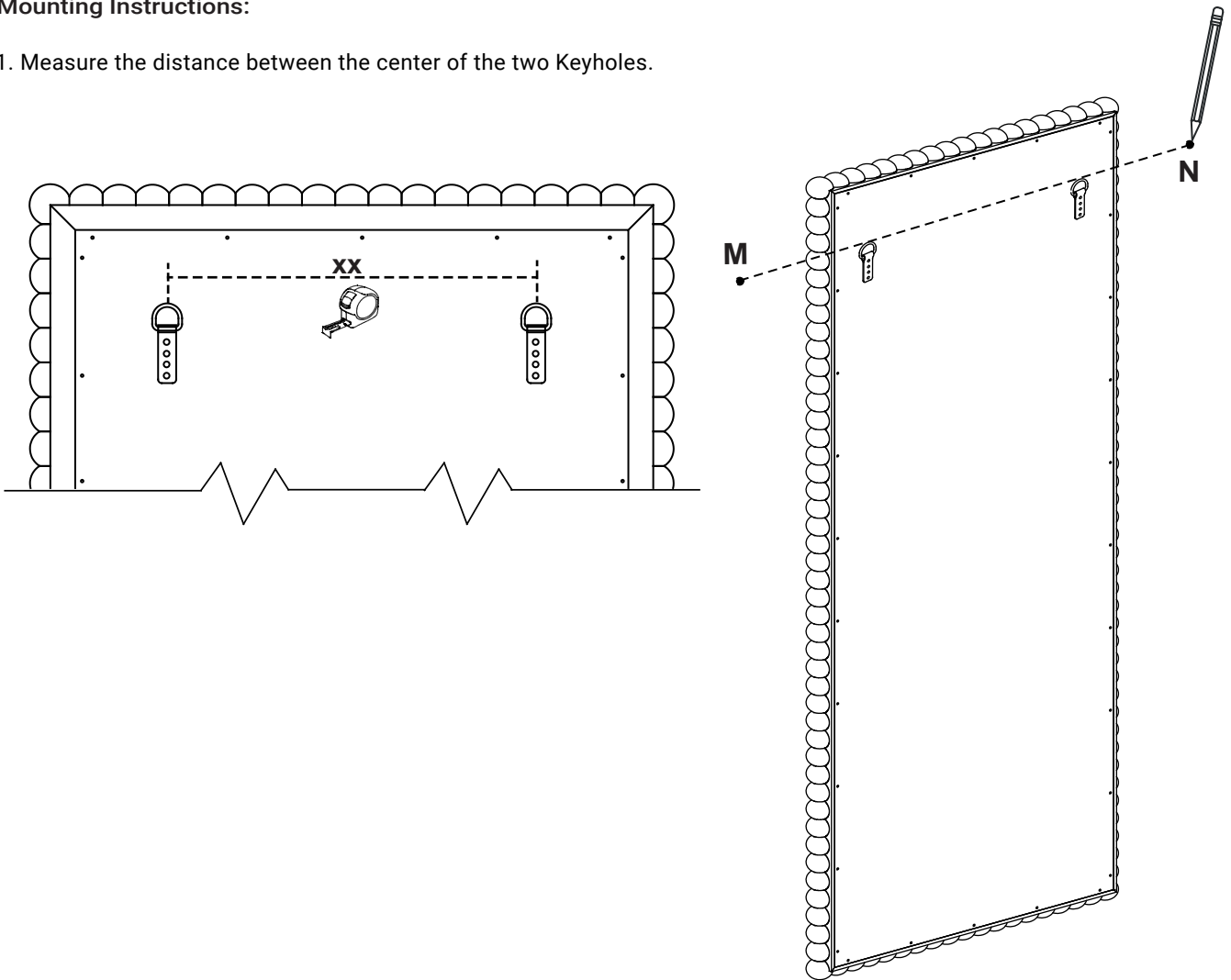

2. Connect the two points (M, N) with a light pencil line, make two insertion marks (P, Q) centered along the line using the measurement "xx".

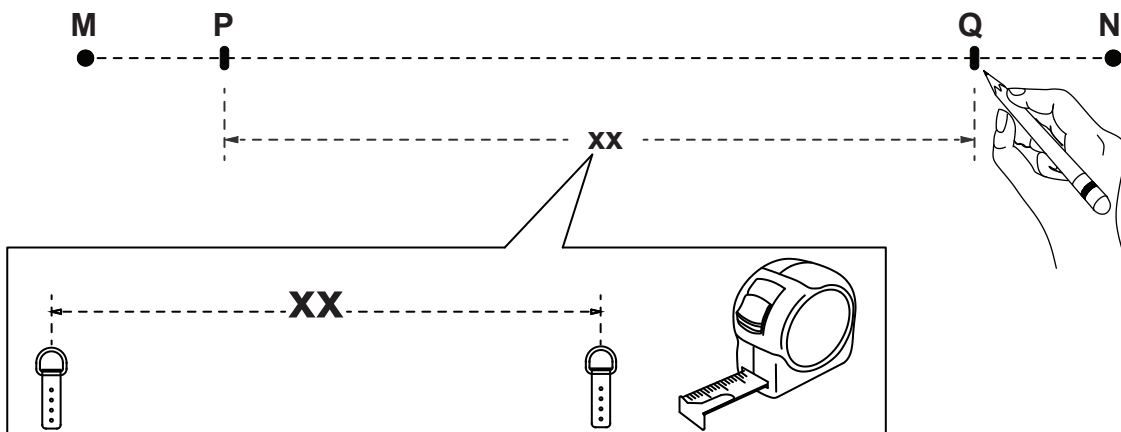

3. Use a stud-finder to determine if there is a wall stud located at either insertion mark. Install the proper hardware, as shown below. Vertically position the plastic bracket against wall at the marked point P & Q, then use the proper hardware to secure the brackets on the wall.

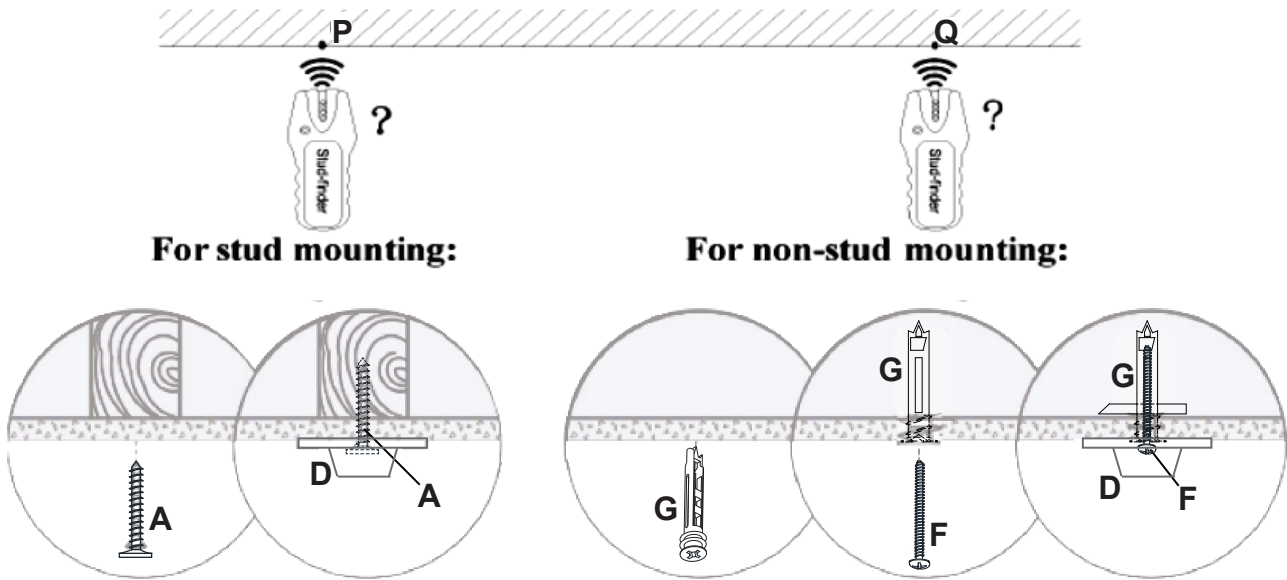

Tips:  
 The anchor is self-drillable.  
 No pilot hole required.

4. Finally, carefully move the mirror back to the location and secure the mirror to the wall using the provided strap. Lace the strap through the bracket and the D-ring as shown, and then slide the thin end of the strap through the receiving end of the plastic strap. Pull to tighten the piece of the mirror snug against the wall. Installation of the Anti-Tip Kit is completed.

\*To remove the strap, depress the small level that is located at the ratchet end of the strap and slide the strap out.

