

⚠ WARNING

READ ALL INSTRUCTIONS COMPLETELY BEFORE STARTING INSTALLATION.

⚠ SAFETY WARNINGS

- THIS FIXTURE IS ONLY SUITABLE FOR DRY LOCATIONS.
- THIS FIXTURE IS EQUIPPED WITH A POLARIZED PLUG (ONE BLADE IS WIDER THAN THE OTHER).
- DO NOT PLUG INTO THE OUTLET UNTIL YOUR LAMP IS FULLY ASSEMBLED.

NOTICE

- The important safeguards and instructions outlined on this sheet cannot cover all possible conditions and situations that may occur. It must be understood that common sense, caution and care factors that cannot be built into any product. Caution and care must be supplied by the person(s) installing, operating and caring of this lighting fixture.
- This fixture is designed to be used on a stable, flat surface.

NOTICE:

CALIFORNIA PROP 65: THIS LIGHTING FIXTURE CONTAINS CHEMICALS KNOWN TO THE STATE OF CALIFORNIA TO CAUSE CANCER, BIRTH DEFECTS, AND/OR OTHER REPRODUCTIVE HARM. WASH HANDS AFTER USE.

FIXTURE PREPARATION

1. Remove the fixture, parts and parts bag(s) from the carton.

NOTICE:

- Before discarding the carton, double check to make certain that all parts are found.

FIXTURE INSTALLATION

1. Insert the harp into the Saddle, and lower the harp caps until they cover the two-pronged saddle.
2. Place the shade to the assembled harp, making sure the top extends through the hole at the top of the shade.
3. Attach the finial and tighten to secure the shade.
4. Install the lamps. (type-A lamp)

NOTICE:

This fixture is rated for 75w type-A lamp.



WARNING

DO NOT EXCEED RECOMMENDED WATTAGE!

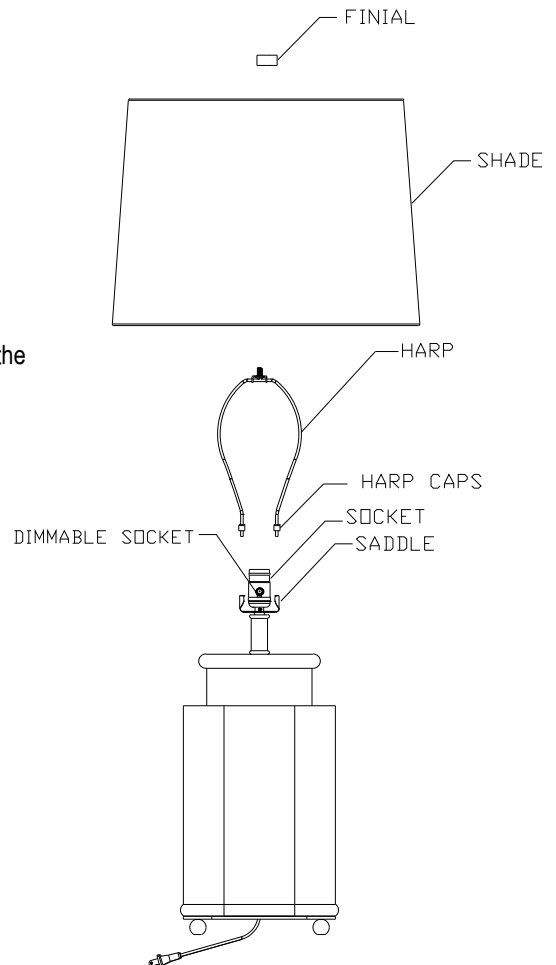

ATTENTION

LISEZ COMPLÈTEMENT TOUTES LES INSTRUCTIONS AVANT DE COMMENCER L'INSTALLATION.

AVERTISSEMENTS DE SÉCURITÉ

- CE LUMINAIRE CONVIENT UNIQUEMENT AUX ENDROITS SECS.
- CE LUMINAIRE EST ÉQUIPÉ D'UNE FICHE POLARISÉE (UNE LAME EST PLUS LARGE QUE L'AUTRE).
- NE BRANCHEZ PAS LA PRISE TANT QUE VOTRE LAMPE N'EST PAS COMPLÈTEMENT ASSEMBLÉE.

AVIS

- Les garanties et instructions importantes décrites sur cette fiche ne peuvent pas couvrir toutes les conditions et situations possibles qui peut se produire. Il faut comprendre que le bon sens, la prudence et les soins sont des facteurs qui ne peuvent être intégrés à aucun produit. La ou les personnes qui installent, utilisent et entretiennent cet appareil d'éclairage doivent faire preuve de prudence et de soins.
- Ce luminaire est conçu pour être utilisé sur une surface stable et plane.

AVIS:

CALIFORNIE PROP 65 : CET APPAREIL D'ÉCLAIRAGE CONTIENT DES PRODUITS CHIMIQUES CONNUS PAR L'ÉTAT DE CALIFORNIE POUR PROVOQUER LE CANCER, DES MALADIES CONGÉNITALES ET/OU D'AUTRES DOMMAGES À LA REPRODUCTION. LAVER LES MAINS APRÈS UTILISATION.

FIXTURE PREPARATION

1. Remove the fixture, parts and parts bag(s) from the carton.

NOTICE:

- Before discarding the carton, double check to make certain that all parts are found.

FIXTURE INSTALLATION

1. Insert the harp into the Saddle, and lower the harp caps until they cover the two-pronged saddle.
2. Place the shade to the assembled harp, making sure the top extends through the hole at the top of the shade.
3. Attach the finial and tighten to secure the shade.
4. Install the lamps. (type-A lamp)

NOTICE:

This fixture is rated for 75w type-A lamp.



WARNING
DO NOT EXCEED RECOMMENDED WATTAGE!

