



# Eco-Downlight

---

LED Downlighting



# Table of Contents

## 1" Eco-Downlight Series

---

1" IC Air-Tight Adjustable New Construction Housing .....	P. 2
1" IC Air-Tight Adjustable New Construction Trims .....	P. 3
1" Non-IC Adjustable New Construction Housing.....	P. 4
1" Non-IC Adjustable New Construction Trims.....	P. 5
1" Non-IC New Construction Housing.....	P. 6
1" Non-IC New Construction Trims.....	P. 7
1" Non-IC Remodel Housing .....	P. 8
1" Non-IC Remodel Trims.....	P. 9

## 3" Eco-Downlight Series

---

3" IC Air-Tight Adjustable New Construction Housing .....	P. 10
3" IC Air-Tight Adjustable New Construction Trims .....	P. 11
3" Non-IC Adjustable New Construction Housing.....	P. 14
3" Non-IC Adjustable New Construction Trims.....	P. 15
3" Shallow IC Air-Tight Adjustable New Construction Housing .....	P. 18
3" Shallow IC Air-Tight Adjustable New Construction Trims .....	P. 20
3" Non-IC New Construction Housing.....	P. 22
3" Non-IC New Construction Trims.....	P. 23
3" Non-IC Remodel Housing .....	P. 24
3" Non-IC Remodel Trims.....	P. 25

## 5" Eco-Downlight Series

---

5" IC Air-Tight New Construction Housing .....	P. 26
5" IC Air-Tight New Construction Trims .....	P. 28
5" Non-IC Adjustable New Construction Housing.....	P. 30
5" Non-IC Adjustable New Construction Trims.....	P. 31
5" Non-IC New Construction Housing.....	P. 34
5" Non-IC New Construction Trims.....	P. 35
5" Non-IC Remodel Housing .....	P. 36
5" Non-IC Remodel Trims.....	P. 37

<b>Index.....</b>	<b>P. 40</b>
-------------------	--------------

# 1" Eco-Downlight

## IC Air-Tight Adjustable New Construction Housing

### Description

Adjustable housing delivers up to 1150lm through a 1" aperture with four optical distributions. Adjustable mechanism allows for precise aiming up to 15° tilt and 359° rotation.

### Field Replaceable LED Light Engine

- 8.5W LED with 2700K or 3000K @ 90 CRI with 2 SDCM binning
- 13W LED with 2700K, 3000K or 3500K @ 90 CRI with 2 SDCM binning

### Field Replaceable Dimming Driver

- 8.5W Low power density (LPD) housings include an universal ELV / Triac driver with 120-277V input
- 13W housings are available with remote Lutron Hi-lume® or universal 0-10V / ELV / Triac driver

### Optics

50° flood optic included (10°, 30° and 80° optic are available, must specify)

### Mounting

Includes (2) galvanized steel adjustable bar hangers for ceiling thicknesses up to 5/8". Above ceiling access required.

### Adjustability

359° horizontal rotation / Up to 15° vertical tilt

### Trims

- Available in round or square aluminum trims, consult factory for custom finishes
- Available in open reflector, baffle or shower trims
- Flush mount adapter available

### Emergency

Remote inverter operates for 90 minutes with remote test switch available, requires above ceiling access.

### Listing / Warranty

- Five (5) year limited warranty
- UL listed to US and Canadian standards for damp locations (Wet location when used with shower trim)
- Meets ASTM E283 standards



### LPD 8.5W Housing Order Matrix (Example: EDLM-ADJ-30-4-LPD)

CCT / CRI	Rev	Wattage / Driver
<b>EDLM-ADJ-27</b> (2700K / 90 CRI)	<b>-4</b>	<b>-LPD</b> (8.5W / ERP, Universal Dim, Triac/ELV 10% 120-277V)
<b>EDLM-ADJ-30</b> (3000K / 90 CRI)		

### Standard 13W Housing Order Matrix (Example: EDLM-ADJ-30-4-LR1)

CCT / CRI	Rev	Wattage / Driver
<b>EDLM-ADJ-27</b> (2700K / 90 CRI)	<b>-4</b>	(blank) (13W / ERP, Universal Dim, Triac/ELV/0-10V 10% 120-277V)
<b>EDLM-ADJ-30</b> (3000K / 90 CRI)		<b>-LR1</b> (13W / Remote Lutron Hi-lume® 2-Wire 1% 120V)
<b>EDLM-ADJ-35</b> (3500K / 90 CRI)		

### Electrical Data

Wattage	CCT / CRI	Delivered Lumens	Efficacy
8.5W	2700K / 90 CRI	750lm	88lpw
8.5W	3000K / 90 CRI	800lm	94lpw
13W	2700K / 90 CRI	950lm	73lpw
13W	3000K / 90 CRI	1050lm	81lpw
13W	3500K / 90 CRI	1150lm	88lpw

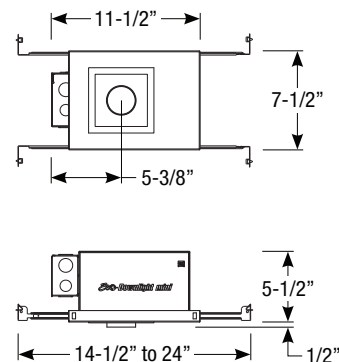

Field Cuttable

Ceiling Cut-out: 2-3/8" Ø

### Trim Accessories

<b>EDLM-RD-FMA</b>	Round Flush Mount Adapter
<b>EDLM-SQ-FMA</b>	Square Flush Mount Adapter

### Optics

<b>EDLM-10-OPTIC-3</b>	(10° Spot)
<b>EDLM-30-OPTIC-3</b>	(30° Narrow Flood)
<b>EDLM-50-OPTIC-3</b>	(50° Flood)
<b>EDLM-80-OPTIC-3</b>	(80° Wide Flood)

### Emergency

<b>EM-1000</b>	(25W LED Remote Inverter)
<b>EM-1002</b>	(10W LED Remote Emergency Driver)
<b>EM-1003</b>	(35W LED Remote Inverter)
<b>EM-1004</b>	(50W LED Remote Inverter)

# 1" Eco-Downlight Trims

## Adjustable Accent Reflector (Allows full adjustability)

EDLM-1301-3 (Round) EDLM-1501-3 (Square) Black Reflector White Flange	EDLM-1303-3 (Round) EDLM-1503-3 (Square) Black Reflector Satin Aluminum Flange	EDLM-1304-3 (Round) EDLM-1504-3 (Square) Haze Reflector White Flange	EDLM-1305-3 (Round) EDLM-1505-3 (Square) Haze Reflector Satin Aluminum Flange	EDLM-1306-3 (Round) EDLM-1506-3 (Square) White Reflector White Flange
--	---	---	--	--

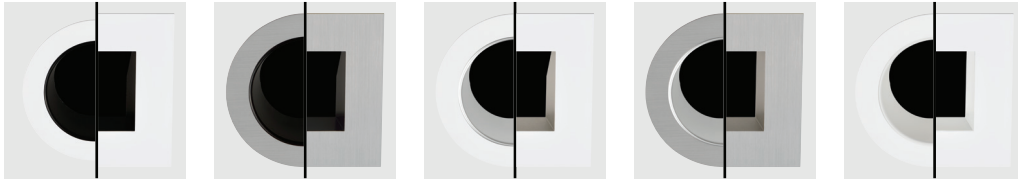

## Open Reflector

EDLM-1001-3 (Round) EDLM-2001-3 (Square) Black Reflector White Flange	EDLM-1003-3 (Round) EDLM-2003-3 (Square) Black Reflector Satin Aluminum Flange	EDLM-1004-3 (Round) EDLM-2004-3 (Square) Haze Reflector White Flange	EDLM-1005-3 (Round) EDLM-2005-3 (Square) Haze Reflector Satin Aluminum Flange	EDLM-1006-3 (Round) EDLM-2006-3 (Square) White Reflector White Flange
--	---	---	--	--

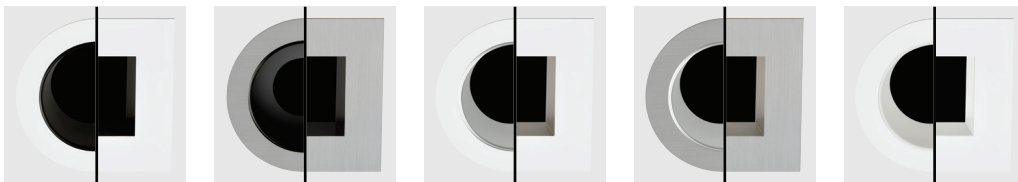

## Adjustable Baffle Downlight (Allows full adjustability)

EDLM-1401-3 (Round) EDLM-1601-3 (Square) Black Baffle White Flange	EDLM-1402-3 (Round) EDLM-1602-3 (Square) Black Baffle Satin Aluminum Flange	EDLM-1403-3 (Round) EDLM-1600-3 (Square) White Baffle White Flange
---	--	---

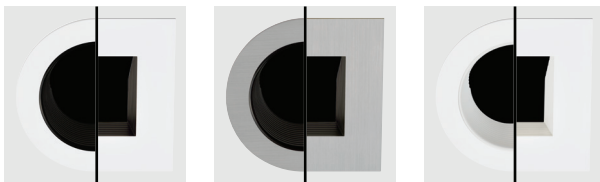

## Baffle Downlight

EDLM-1100-3 (Round) EDLM-2100-3 (Square) White Baffle White Flange	EDLM-1101-3 (Round) EDLM-2101-3 (Square) Black Baffle White Flange	EDLM-1102-3 (Round) EDLM-2102-3 (Square) Black Baffle Satin Aluminum Flange
---	---	--

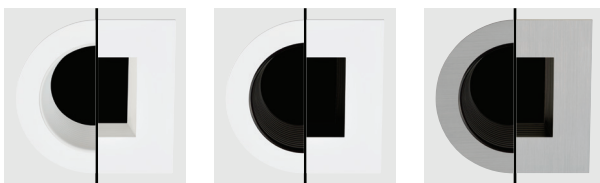

## Shower Trim

EDLM-1200-3 Round White Flange	EDLM-2200-3 Square White Flange
-----------------------------------	------------------------------------



# 1" Eco-Downlight

## Non-IC Adjustable New Construction Housing

### Description

Adjustable housing delivers up to 1150lm through a 1" aperture with four optical distributions. New construction housing is rated for non insulated ceilings and adjustable mechanism allows for precise aiming up to 15° tilt and 359° rotation.

### Field Replaceable LED Light Engine

- 8.5W LED with 2700K or 3000K @ 90 CRI with 2 SDCM binning
- 13W LED with 2700K, 3000K or 3500K @ 90 CRI with 2 SDCM binning

### Field Replaceable Dimming Driver

- 8.5W Low power density (LPD) housings include an universal ELV / Triac driver with 120-277V input
- 13W housings are available with remote Lutron Hi-lume® or universal 0-10V / ELV / Triac driver

### Optics

50° flood optic included (10°, 30° and 80° optic are available, must specify)

### Mounting

Includes (2) galvanized steel adjustable bar hangers for ceiling thicknesses up to 5/8". Above ceiling access required.

### Adjustability

359° horizontal rotation / Up to 15° vertical tilt

### Trims

- Available in round or square aluminum trims, consult factory for custom finishes
- Available in open reflector, baffle or shower trims
- Flush mount adapter available

### Emergency

Remote inverter operates for 90 minutes with remote test switch available, requires above ceiling access.

### Listing / Warranty

- Five (5) year limited warranty
- UL listed to US and Canadian standards for damp locations (Wet location when used with shower trim)



### Electrical Data

Wattage	CCT / CRI	Delivered Lumens	Efficacy
8.5W	2700K / 90 CRI	750lm	88lpw
8.5W	3000K / 90 CRI	800lm	94lpw
13W	2700K / 90 CRI	950lm	73lpw
13W	3000K / 90 CRI	1050lm	81lpw
13W	3500K / 90 CRI	1150lm	88lpw

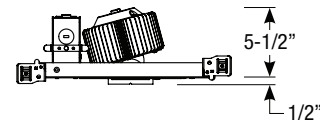
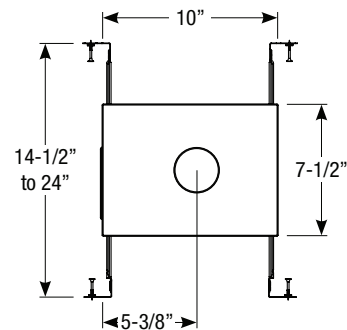

Field Cuttable  
Ceiling Cut-out: 2-3/8" Ø

### Trim Accessories

<b>EDLM-RD-FMA</b>	Round Flush Mount Adapter
<b>EDLM-SQ-FMA</b>	Square Flush Mount Adapter

### Optics

<b>EDLM-10-OPTIC-3</b>	(10° Spot)
<b>EDLM-30-OPTIC-3</b>	(30° Narrow Flood)
<b>EDLM-50-OPTIC-3</b>	(50° Flood)
<b>EDLM-80-OPTIC-3</b>	(80° Wide Flood)

### Emergency

<b>EM-1000</b>	(25W LED Remote Inverter)
<b>EM-1002</b>	(10W LED Remote Emergency Driver)
<b>EM-1003</b>	(35W LED Remote Inverter)
<b>EM-1004</b>	(50W LED Remote Inverter)

### LPD 8.5W Housing Order Matrix (Example: EDLM-NCADJ-30-4-LPD)

CCT / CRI	Rev	Wattage / Driver
<b>EDLM-NCADJ-27</b> (2700K / 90 CRI) <b>EDLM-NCADJ-30</b> (3000K / 90 CRI)	<b>-4</b>	<b>-LPD</b> (8.5W / ERP, Universal Dim, Triac/ELV 10% 120-277V)

### Standard 13W Housing Order Matrix (Example: EDLM-NCADJ-30-4-LR1)

CCT / CRI	Rev	Wattage / Driver
<b>EDLM-NCADJ-27</b> (2700K / 90 CRI) <b>EDLM-NCADJ-30</b> (3000K / 90 CRI) <b>EDLM-NCADJ-35</b> (3500K / 90 CRI)	<b>-4</b>	(blank) (13W / ERP, Universal Dim, Triac/ELV/0-10V 10% 120-277V) <b>-LR1</b> (13W / Remote Lutron Hi-lume® 2-Wire 1% 120V)

# 1" Eco-Downlight Trims

**Adjustable Accent Reflector (Allows full adjustability)**

- |                      |                       |                      |                       |                      |
|----------------------|-----------------------|----------------------|-----------------------|----------------------|
| EDLM-1301-3 (Round)  | EDLM-1303-3 (Round)   | EDLM-1304-3 (Round)  | EDLM-1305-3 (Round)   | EDLM-1306-3 (Round)  |
| EDLM-1501-3 (Square) | EDLM-1503-3 (Square)  | EDLM-1504-3 (Square) | EDLM-1505-3 (Square)  | EDLM-1506-3 (Square) |
| Black Reflector      | Black Reflector       | Haze Reflector       | Haze Reflector        | White Reflector      |
| White Flange         | Satin Aluminum Flange | White Flange         | Satin Aluminum Flange | White Flange         |

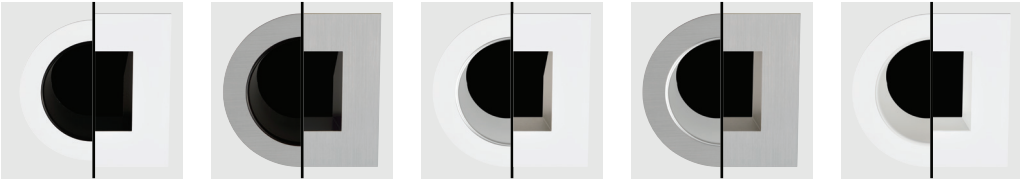

**Open Reflector**

- |                      |                       |                      |                       |                      |
|----------------------|-----------------------|----------------------|-----------------------|----------------------|
| EDLM-1001-3 (Round)  | EDLM-1003-3 (Round)   | EDLM-1004-3 (Round)  | EDLM-1005-3 (Round)   | EDLM-1006-3 (Round)  |
| EDLM-2001-3 (Square) | EDLM-2003-3 (Square)  | EDLM-2004-3 (Square) | EDLM-2005-3 (Square)  | EDLM-2006-3 (Square) |
| Black Reflector      | Black Reflector       | Haze Reflector       | Haze Reflector        | White Reflector      |
| White Flange         | Satin Aluminum Flange | White Flange         | Satin Aluminum Flange | White Flange         |

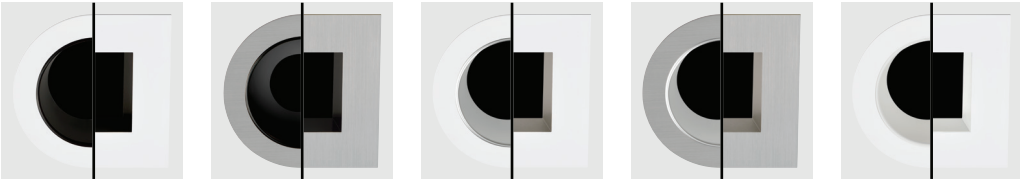

**Adjustable Baffle Downlight (Allows full adjustability)**

- |                      |                       |                      |
|----------------------|-----------------------|----------------------|
| EDLM-1401-3 (Round)  | EDLM-1402-3 (Round)   | EDLM-1403-3 (Round)  |
| EDLM-1601-3 (Square) | EDLM-1602-3 (Square)  | EDLM-1600-3 (Square) |
| Black Baffle         | Black Baffle          | White Baffle         |
| White Flange         | Satin Aluminum Flange | White Flange         |

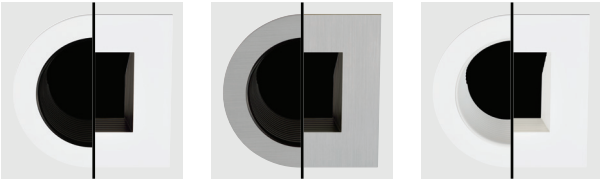

**Baffle Downlight**

- |                      |                      |                       |
|----------------------|----------------------|-----------------------|
| EDLM-1100-3 (Round)  | EDLM-1101-3 (Round)  | EDLM-1102-3 (Round)   |
| EDLM-2100-3 (Square) | EDLM-2101-3 (Square) | EDLM-2102-3 (Square)  |
| White Baffle         | Black Baffle         | Black Baffle          |
| White Flange         | White Flange         | Satin Aluminum Flange |

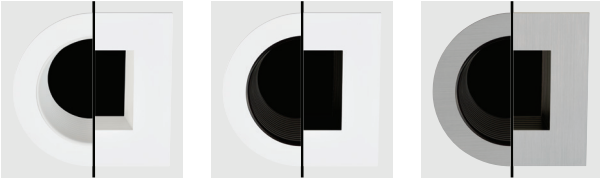

**Shower Trim**

- |                    |                     |
|--------------------|---------------------|
| EDLM-1200-3        | EDLM-2200-3         |
| Round White Flange | Square White Flange |



# 1" Eco-Downlight

## Non-IC New Construction Housing

### Description

Downlight housing delivers up to 1150lm through a 1" aperture with four optical distributions. New construction housing is rated for non insulated ceilings.

### Field Replaceable LED Light Engine

- 8.5W LED with 2700K or 3000K @ 90 CRI with 2 SDCM binning
- 13W LED with 2700K, 3000K or 3500K @ 90 CRI with 2 SDCM binning

### Field Replaceable Dimming Driver

- 8.5W Low power density (LPD) housings include an universal ELV / Triac driver with 120-277V input
- 13W housings are available with remote Lutron Hi-lume® or universal 0-10V / ELV / Triac driver

### Optics

50° flood optic included (10°, 30° and 80° optic are available, must specify)

### Mounting

- Tension clips allow housing to adjust vertically for ceiling thicknesses from 1/2" to 3/4"
- Requires a minimum ceiling depth of 6-1/2"

### Gasket for IC Installations

8.5W Low power density (LPD) housings are available with IC Air-Tight gasket, must specify EDLM-AT-GSKT.

### Trims

- Available in round or square aluminum trims, consult factory for custom finishes
- Available in open reflector, baffle or shower trims
- Flush mount adapter available

### Emergency

Remote inverter operates for 90 minutes with remote test switch available, requires above ceiling access.

### Listing / Warranty

- Five (5) year limited warranty
- UL listed to US and Canadian standards for damp locations (Wet location when used with shower trim)



### LPD 8.5W Housing Order Matrix (Example: EDLM-NC-30-4-LPD)

CCT / CRI	Rev	Wattage / Driver
<b>EDLM-NC-27</b> (2700K / 90 CRI)	<b>-4</b>	<b>-LPD</b> (8.5W / ERP, Universal Dim, Triac/ELV 10% 120-277V)
<b>EDLM-NC-30</b> (3000K / 90 CRI)		

### Standard 13W Housing Order Matrix (Example: EDLM-NC-30-4-LR1)

CCT / CRI	Rev	Wattage / Driver
<b>EDLM-NC-27</b> (2700K / 90 CRI)	<b>-4</b>	(blank) (13W / ERP, Universal Dim, Triac/ELV/0-10V 10% 120-277V)
<b>EDLM-NC-30</b> (3000K / 90 CRI)		<b>-LR1</b> (13W / Remote Lutron Hi-lume® 2-Wire 1% 120V)
<b>EDLM-NC-35</b> (3500K / 90 CRI)		

### Electrical Data

Wattage	CCT / CRI	Delivered Lumens	Efficacy
8.5W	2700K / 90 CRI	750lm	88lpw
8.5W	3000K / 90 CRI	800lm	94lpw
13W	2700K / 90 CRI	950lm	73lpw
13W	3000K / 90 CRI	1050lm	81lpw
13W	3500K / 90 CRI	1150lm	88lpw

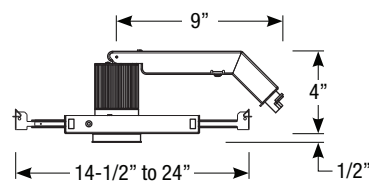
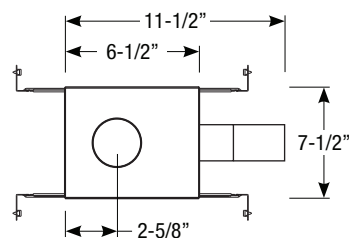

Field Cuttable  
Ceiling Cut-out: 2-3/8" Ø

### Housing & Trim Accessories

<b>EDLM-AT-GSKT</b>	Air-Tight IC Gasket for LPD housing
<b>EDLM-RD-FMA</b>	Round Flush Mount Adapter
<b>EDLM-SQ-FMA</b>	Square Flush Mount Adapter

### Optics

<b>EDLM-10-OPTIC-3</b>	(10° Spot)
<b>EDLM-30-OPTIC-3</b>	(30° Narrow Flood)
<b>EDLM-50-OPTIC-3</b>	(50° Flood)
<b>EDLM-80-OPTIC-3</b>	(80° Wide Flood)

### Emergency

<b>EM-1000</b>	(25W LED Remote Inverter)
<b>EM-1002</b>	(10W LED Remote Emergency Driver)
<b>EM-1003</b>	(35W LED Remote Inverter)
<b>EM-1004</b>	(50W LED Remote Inverter)



# 1" Eco-Downlight Trims

## Open Reflector

EDLM-1001-3  
Black Reflector  
White Flange



EDLM-1003-3  
Black Reflector  
Satin Aluminum Flange

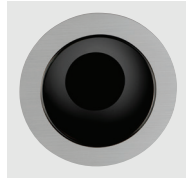

EDLM-1004-3  
Haze Reflector  
White Flange

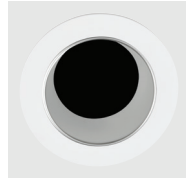

EDLM-1005-3  
Haze Reflector  
Satin Aluminum Flange

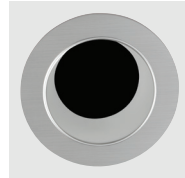

EDLM-1006-3  
White Reflector  
White Flange

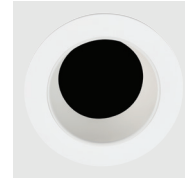

EDLM-2001-3  
Black Reflector  
White Flange

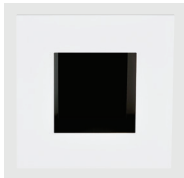

EDLM-2003-3  
Black Reflector  
Satin Aluminum Flange

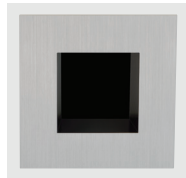

EDLM-2004-3  
Haze Reflector  
White Flange

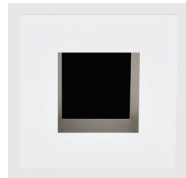

EDLM-2005-3  
Haze Reflector  
Satin Aluminum Flange

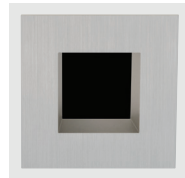

EDLM-2006-3  
White Reflector  
White Flange



## Baffle Downlight

EDLM-1100-3  
White Baffle  
White Flange



EDLM-1101-3  
Black Baffle  
White Flange

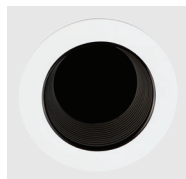

EDLM-1102-3  
Black Baffle  
Satin Aluminum Flange



EDLM-2100-3  
White Baffle  
White Flange

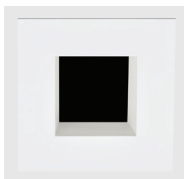

EDLM-2101-3  
Black Baffle  
White Flange

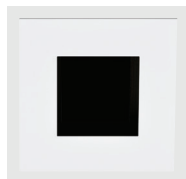

EDLM-2102-3  
Black Baffle  
Satin Aluminum Flange



## Shower Trim

EDLM-1200-3  
Round White Flange



EDLM-2200-3  
Square White Flange



# 1" Eco-Downlight

## Non-IC Remodel Housing

### Description

Downlight housing delivers up to 1150lm through a 1" aperture with four optical distributions. Remodel housing is rated for non insulated ceilings.

### Field Replaceable LED Light Engine

- 8.5W LED with 2700K or 3000K @ 90 CRI with 2 SDCM binning
- 13W LED with 2700K, 3000K or 3500K @ 90 CRI with 2 SDCM binning

### Field Replaceable Dimming Driver

- 8.5W Low power density (LPD) housings include an universal ELV / Triac driver with 120-277V input
- 13W housings are available with remote Lutron Hi-lume® or universal 0-10V / ELV / Triac driver

### Optics

50° flood optic included (10°, 30° and 80° optic are available, must specify)

### Mounting

- Tension clips allow housing to adjust vertically for ceiling thicknesses from 1/2" to 3/4"
- Requires a minimum ceiling depth of 6-1/2"

### Gasket for IC Installations

8.5W Low power density (LPD) housings are available with IC Air-Tight gasket, must specify EDLM-AT-GSKT.

### Trims

- Available in round or square aluminum trims, consult factory for custom finishes
- Available in open reflector, baffle or shower trims
- Flush mount adapter available

### Emergency

Remote inverter operates for 90 minutes with remote test switch available, requires above ceiling access.

### Listing / Warranty

- Five (5) year limited warranty
- UL listed to US and Canadian standards for damp locations (Wet location when used with shower trim)



### LPD 8.5W Housing Order Matrix (Example: EDLM-RM-30-4-LPD)

CCT / CRI	Rev	Wattage / Driver
<b>EDLM-RM-27</b> (2700K / 90 CRI) <b>EDLM-RM-30</b> (3000K / 90 CRI)	<b>-4</b>	<b>-LPD</b> (8.5W / ERP, Universal Dim, Triac/ELV 10% 120-277V)

### Standard 13W Housing Order Matrix (Example: EDLM-RM-30-4-LR1)

CCT / CRI	Rev	Wattage / Driver
<b>EDLM-RM-27</b> (2700K / 90 CRI) <b>EDLM-RM-30</b> (3000K / 90 CRI) <b>EDLM-RM-35</b> (3500K / 90 CRI)	<b>-4</b>	(blank) (13W / ERP, Universal Dim, Triac/ELV/0-10V 10% 120-277V) <b>-LR1</b> (13W / Remote Lutron Hi-lume® 2-Wire 1% 120V)

### Electrical Data

Wattage	CCT / CRI	Delivered Lumens	Efficacy
8.5W	2700K / 90 CRI	750lm	88lpw
8.5W	3000K / 90 CRI	800lm	94lpw
13W	2700K / 90 CRI	950lm	73lpw
13W	3000K / 90 CRI	1050lm	81lpw
13W	3500K / 90 CRI	1150lm	88lpw

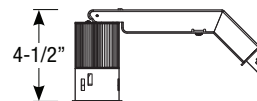
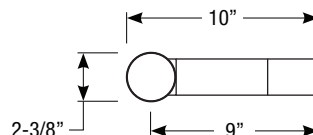

Ceiling Cut-out: 2-1/4" Ø

### Housing & Trim Accessories

<b>EDLM-AT-GSKT</b>	Air-Tight IC Gasket for LPD housing
<b>EDLM-RD-FMA</b>	Round Flush Mount Adapter
<b>EDLM-SQ-FMA</b>	Square Flush Mount Adapter

### Optics

<b>EDLM-10-OPTIC-3</b>	(10° Spot)
<b>EDLM-30-OPTIC-3</b>	(30° Narrow Flood)
<b>EDLM-50-OPTIC-3</b>	(50° Flood)
<b>EDLM-80-OPTIC-3</b>	(80° Wide Flood)

### Emergency

<b>EM-1000</b>	(25W LED Remote Inverter)
<b>EM-1002</b>	(10W LED Remote Emergency Driver)
<b>EM-1003</b>	(35W LED Remote Inverter)
<b>EM-1004</b>	(50W LED Remote Inverter)

# 1" Eco-Downlight Trims

### Open Reflector

EDLM-1001-3  
Black Reflector  
White Flange



EDLM-1003-3  
Black Reflector  
Satin Aluminum Flange



EDLM-1004-3  
Haze Reflector  
White Flange



EDLM-1005-3  
Haze Reflector  
Satin Aluminum Flange



EDLM-1006-3  
White Reflector  
White Flange

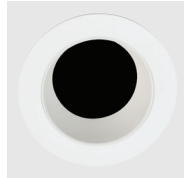

EDLM-2001-3  
Black Reflector  
White Flange

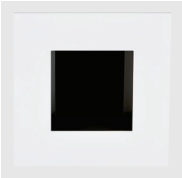

EDLM-2003-3  
Black Reflector  
Satin Aluminum Flange



EDLM-2004-3  
Haze Reflector  
White Flange

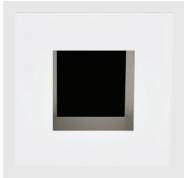

EDLM-2005-3  
Haze Reflector  
Satin Aluminum Flange

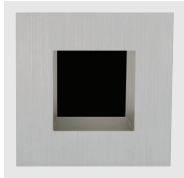

EDLM-2006-3  
White Reflector  
White Flange

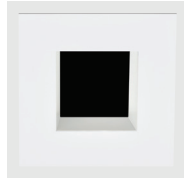

### Baffle Downlight

EDLM-1100-3  
White Baffle  
White Flange



EDLM-1101-3  
Black Baffle  
White Flange



EDLM-1102-3  
Black Baffle  
Satin Aluminum Flange



EDLM-2100-3  
White Baffle  
White Flange

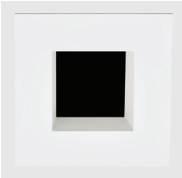

EDLM-2101-3  
Black Baffle  
White Flange

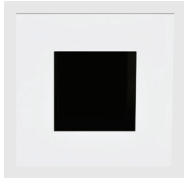

EDLM-2102-3  
Black Baffle  
Satin Aluminum Flange



### Shower Trim

EDLM-1200-3  
Round White Flange



EDLM-2200-3  
Square White Flange



# 3" Eco-Downlight

## IC Air-Tight Adjustable New Construction Housing

### Description

Adjustable housing delivers up to 2000lm through a 3" aperture with four optical distributions. Adjustable mechanism allows for precise aiming up to 45° tilt and 359° rotation.

### Field Replaceable LED Light Engine

- 13W LED with 2700K or 3000K @ 90 CRI with 2 SDCM binning
- 21W LED with 2700K, 3000K or 3500K @ 90 CRI with 2 SDCM binning

### Field Replaceable Dimming Driver

- 13W Low power density (LPD) housings include an universal ELV / Triac driver with 120-277V input
- 21W housings are available with remote Lutron Hi-lume® or universal 0-10V / ELV / Triac driver

### Optics

50° flood optic included (10°, 30° and 80° optic are available, must specify)

### Mounting

Includes (2) galvanized steel adjustable bar hangers for ceiling thicknesses up to 1"

### Adjustability

359° horizontal rotation / Up to 45° vertical tilt

### Trims

- Available in round or square aluminum trims, consult factory for custom finishes
- Available in open reflector, baffle, shower or wall wash trims
- Flush mount adapter and trimless mud plate available

### Emergency

Remote inverter operates for 90 minutes with remote test switch available, requires above ceiling access.

### Listing / Warranty

- Five (5) year limited warranty
- UL listed to US and Canadian standards for damp locations (Wet location when used with shower trim)
- Meets ASTM E283 standards



### LPD 13W Housing Order Matrix (Example: EDL-ADJ-30-5-LPD)

CCT / CRI	Rev	Wattage / Driver
<b>EDL-ADJ-27</b> (2700K / 90 CRI) <b>EDL-ADJ-30</b> (3000K / 90 CRI)	-5	-LPD (13W / ERP, Universal Dim, Triac/ELV 10% 120-277V)

### Standard 21W Housing Order Matrix (Example: EDL-ADJ-30-5-LR1)

CCT / CRI	Rev	Wattage / Driver
<b>EDL-ADJ-27</b> (2700K / 90 CRI) <b>EDL-ADJ-30</b> (3000K / 90 CRI) <b>EDL-ADJ-35</b> (3500K / 90 CRI)	-5	(blank) (21W / ERP, Universal Dim, Triac/ELV/0-10V 10% 120-277V) -LR1 (21W / Remote Lutron Hi-lume® 2-Wire 1% 120V)

### Electrical Data

Wattage	CCT / CRI	Delivered Lumens	Efficacy
13W	2700K / 90 CRI	1000lm	77lpw
13W	3000K / 90 CRI	1200lm	92lpw
21W	2700K / 90 CRI	1700lm	81lpw
21W	3000K / 90 CRI	1850lm	88lpw
21W	3500K / 90 CRI	2000lm	95lpw

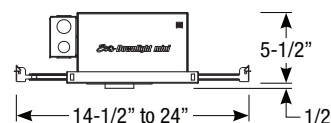
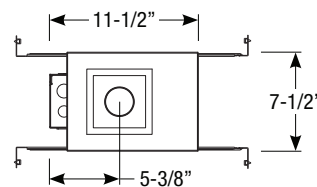
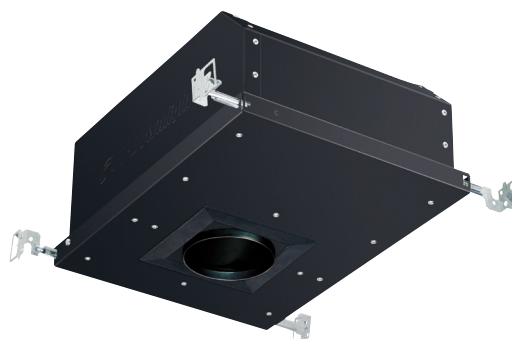

Field Cuttable  
Ceiling Cut-out: 3-7/8" Ø

### Housing Accessories

<b>EDL-MHLDR-4</b>	Media Holder - required for lenses
<b>EDL-FT-4</b>	Frosted Lens
<b>EDL-MP-4</b>	Solite Lens
<b>EDL-CL-4</b>	Clear Lens
<b>EDL-LN-4</b>	Linear Spread Lens

### Trim Accessories

<b>EDL-RD-TR-4</b>	Round Trimless Mud Plate
<b>EDL-RD-FMA</b>	Round Flush Mount Adapter
<b>EDL-SQ-FMA</b>	Square Flush Mount Adapter

### Optics

<b>EDL-10-OPTIC-5</b>	(10° Spot)
<b>EDL-30-OPTIC-4</b>	(30° Narrow Flood)
<b>EDL-50-OPTIC-4</b>	(50° Flood)
<b>EDL-80-OPTIC-4</b>	(80° Wide Flood)

### Emergency

<b>EM-1000</b>	(25W LED Remote Inverter)
<b>EM-1002</b>	(10W LED Remote Emergency Driver)
<b>EM-1003</b>	(35W LED Remote Inverter)
<b>EM-1004</b>	(50W LED Remote Inverter)

# 3" Eco-Downlight Trims

## Adjustable Accent Reflector (Allows full adjustability)

EDL-1300-4 Clear Alzak Reflector White Flange	EDL-1301-4 (Round) EDL-1501-4 (Square) Black Reflector White Flange	EDL-1302-4 Clear Alzak Reflector Satin Aluminum Flange	EDL-1303-4 (Round) EDL-1503-4 (Square) Black Reflector Satin Aluminum Flange	EDL-1304-4 (Round) EDL-1502-4 (Square) Haze Reflector White Flange	EDL-1305-4 (Round) EDL-1504-4 (Square) Haze Reflector Satin Aluminum Flange	EDL-1306-4 (Round) EDL-1500-4 (Square) White Reflector White Flange	EDL-1307-4 (Round) EDL-1505-4 (Square) Bronze Reflector Bronze Flange
---	--	--	---	---	--	--	--

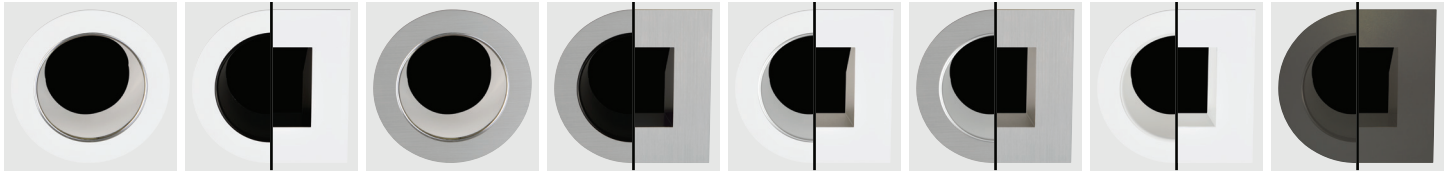

EDL-7000-4* White Reflector Trimless	EDL-7001-4* Satin Aluminum Reflector Trimless	EDL-7002-4* Bronze Reflector Trimless	EDL-7003-4* Black Alzak Reflector Trimless
--	---	---	--

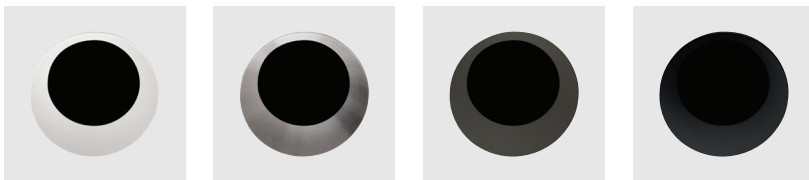

\* Trimless requires mud plate (EDL-RD-TR-4)

## Open Downlight

EDL-1000-4 Clear Alzak Reflector White Flange	EDL-1001-4 (Round) EDL-2001-4 (Square) Black Reflector White Flange	EDL-1002-4 Clear Alzak Reflector Satin Aluminum Flange	EDL-1003-4 (Round) EDL-2003-4 (Square) Black Reflector Satin Aluminum Flange	EDL-1004-4 (Round) EDL-2002-4 (Square) Haze Reflector White Flange	EDL-1005-4 (Round) EDL-2004-4 (Square) Haze Reflector Satin Aluminum Flange	EDL-1006-4 (Round) EDL-2000-4 (Square) White Reflector White Flange	EDL-1007-4 (Round) EDL-2005-4 (Square) Bronze Reflector Bronze Flange
---	--	--	---	---	--	--	--

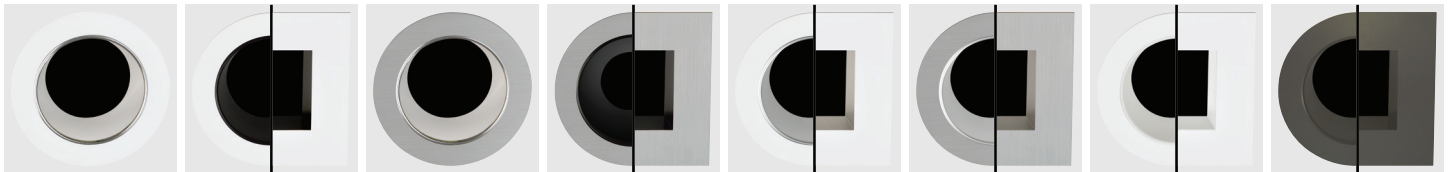

EDL-5000-4* White Reflector Trimless	EDL-5001-4* Satin Aluminum Reflector Trimless	EDL-5002-4* Bronze Reflector Trimless	EDL-5003-4* Black Alzak Reflector Trimless
--	---	---	--

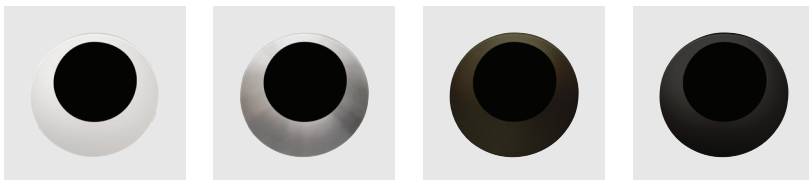

\* Trimless requires mud plate (EDL-RD-TR-4)

# 3" Eco-Downlight Trims

## Adjustable Baffle Downlight (Allows full adjustability)

EDL-1400-4 (Round) EDL-1600-4 (Square) White Baffle White Flange	EDL-1401-4 (Round) EDL-1601-4 (Square) Black Baffle White Flange	EDL-1402-4 (Round) EDL-1602-4 (Square) Black Baffle Satin Aluminum Flange	EDL-1403-4 (Round) EDL-1603-4 (Square) Bronze Baffle Bronze Flange
---	---	--	---

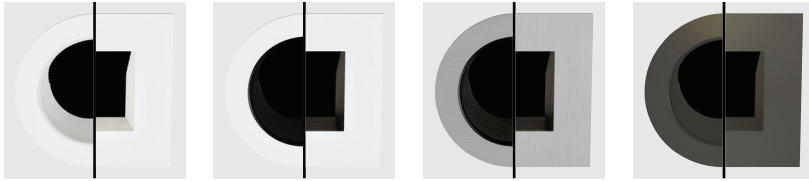

EDL-7100-4* White Baffle Trimless	EDL-7101-4* Satin Aluminum Baffle Trimless	EDL-7102-4* Bronze Baffle Trimless	EDL-7103-4* Black Baffle Trimless
---	--	--	---

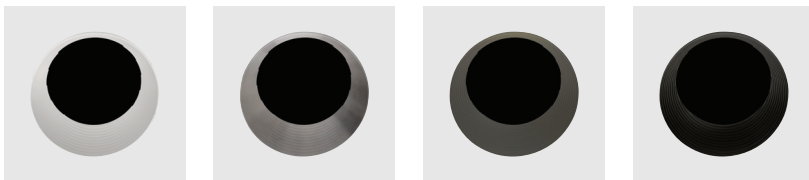

\* Trimless requires mud plate (EDL-RD-TR-4)

## Baffle Downlight

EDL-1100-4 (Round) EDL-2100-4 (Square) White Baffle White Flange	EDL-1101-4 (Round) EDL-2101-4 (Square) Black Baffle White Flange	EDL-1102-4 (Round) EDL-2102-4 (Square) Black Baffle Satin Aluminum Flange	EDL-1103-4 (Round) EDL-2103-4 (Square) Bronze Baffle Bronze Flange
---	---	--	---

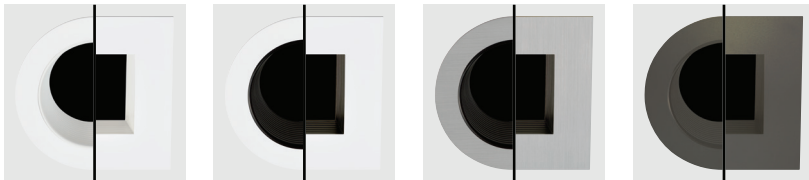

EDL-5100-4* White Baffle Trimless	EDL-5101-4* Satin Aluminum Baffle Trimless	EDL-5102-4* Bronze Baffle Trimless	EDL-5103-4* Black Baffle Trimless
---	--	--	---

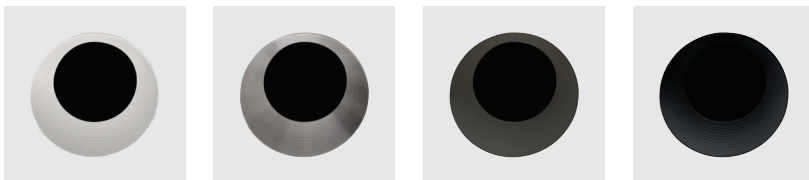

\* Trimless requires mud plate (EDL-RD-TR-4)

# 3" Eco-Downlight Trims

## Adjustable Shower Trim (Allows full adjustability)



## Shower Trim



## Wall Wash Trims

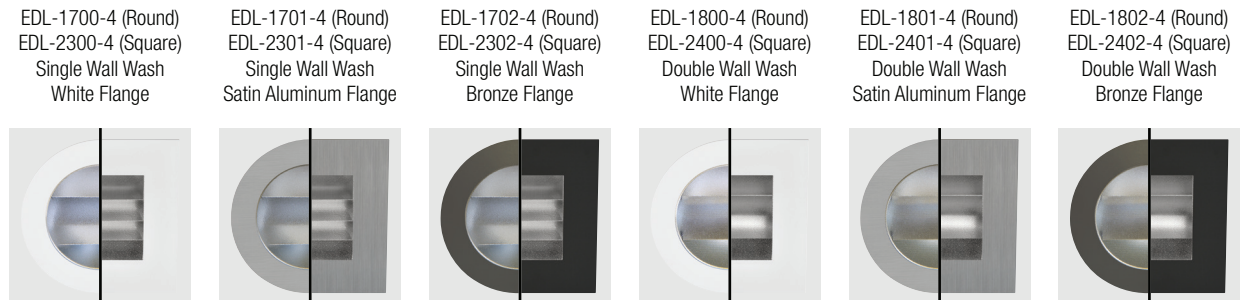

# 3" Eco-Downlight

## Non-IC Adjustable New Construction Housing

### Description

Adjustable housing delivers up to 2000lm through a 3" aperture with four optical distributions. New construction housing is rated for non insulated ceilings and adjustable mechanism allows for precise aiming up to 45° tilt and 359° rotation.

### Field Replaceable LED Light Engine

- 13W LED with 2700K or 3000K @ 90 CRI with 2 SDCM binning
- 21W LED with 2700K, 3000K or 3500K @ 90 CRI with 2 SDCM binning

### Field Replaceable Dimming Driver

- 13W Low power density (LPD) housings include an universal ELV / Triac driver with 120-277V input
- 21W housings are available with remote Lutron Hi-lume® or universal 0-10V / ELV / Triac driver

### Optics

50° flood optic included (10°, 30° and 80° optic are available, must specify)

### Mounting

Includes (2) galvanized steel adjustable bar hangers for ceiling thicknesses up to 1"

### Adjustability

359° horizontal rotation / Up to 45° vertical tilt

### Trims

- Available in round or square aluminum trims, consult factory for custom finishes
- Available in open reflector, baffle, shower or wall wash trims
- Flush mount adapter and trimless mud plate available

### Emergency

Remote inverter operates for 90 minutes with remote test switch available, requires above ceiling access.

### Listing / Warranty

- Five (5) year limited warranty
- UL listed to US and Canadian standards for damp locations (Wet location when used with shower trim)



### Electrical Data

Wattage	CCT / CRI	Delivered Lumens	Efficacy
13W	2700K / 90 CRI	1000lm	77lpw
13W	3000K / 90 CRI	1200lm	92lpw
21W	2700K / 90 CRI	1700lm	81lpw
21W	3000K / 90 CRI	1850lm	88lpw
21W	3500K / 90 CRI	2000lm	95lpw

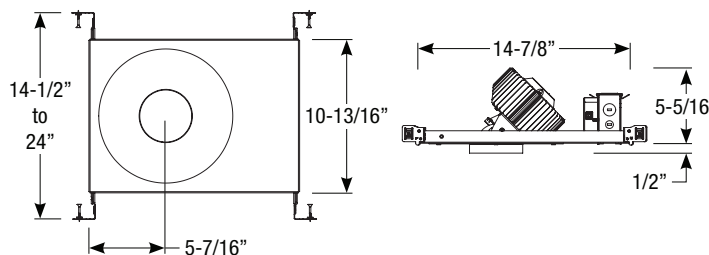

Field Cuttable  
Ceiling Cut-out: 3-7/8" Ø

### Housing Accessories

<b>EDL-MHLDR-4</b>	Media Holder - required for lenses
<b>EDL-FT-4</b>	Frosted Lens
<b>EDL-MP-4</b>	Solite Lens
<b>EDL-CL-4</b>	Clear Lens
<b>EDL-LN-4</b>	Linear Spread Lens

### Trim Accessories

<b>EDL-RD-TR-4</b>	Round Trimless Mud Plate
<b>EDL-RD-FMA</b>	Round Flush Mount Adapter
<b>EDL-SQ-FMA</b>	Square Flush Mount Adapter

### Optics

<b>EDL-10-OPTIC-5</b>	(10° Spot)
<b>EDL-30-OPTIC-4</b>	(30° Narrow Flood)
<b>EDL-50-OPTIC-4</b>	(50° Flood)
<b>EDL-80-OPTIC-4</b>	(80° Wide Flood)

### Emergency

<b>EM-1000</b>	(25W LED Remote Inverter)
<b>EM-1002</b>	(10W LED Remote Emergency Driver)
<b>EM-1003</b>	(35W LED Remote Inverter)
<b>EM-1004</b>	(50W LED Remote Inverter)

### LPD 13W Housing Order Matrix (Example: EDL-NCADJ-30-5-LPD)

CCT / CRI	Rev	Wattage / Driver
<b>EDL-NCADJ-27</b> (2700K / 90 CRI) <b>EDL-NCADJ-30</b> (3000K / 90 CRI)	-5	-LPD (13W / ERP, Universal Dim, Triac/ELV 10% 120-277V)

### Standard 21W Housing Order Matrix (Example: EDL-NCADJ-30-5-LR1)

CCT / CRI	Rev	Wattage / Driver
<b>EDL-NCADJ-27</b> (2700K / 90 CRI) <b>EDL-NCADJ-30</b> (3000K / 90 CRI) <b>EDL-NCADJ-35</b> (3500K / 90 CRI)	-5	(blank) (21W / ERP, Universal Dim, Triac/ELV/0-10V 10% 120-277V) -LR1 (21W / Remote Lutron Hi-lume® 2-Wire 1% 120V)



# 3" Eco-Downlight Trims

## Adjustable Accent Reflector (Allows full adjustability)

EDL-1300-4 Clear Alzak Reflector White Flange	EDL-1301-4 (Round) EDL-1501-4 (Square) Black Reflector White Flange	EDL-1302-4 Clear Alzak Reflector Satin Aluminum Flange	EDL-1303-4 (Round) EDL-1503-4 (Square) Black Reflector Satin Aluminum Flange	EDL-1304-4 (Round) EDL-1502-4 (Square) Haze Reflector White Flange	EDL-1305-4 (Round) EDL-1504-4 (Square) Haze Reflector Satin Aluminum Flange	EDL-1306-4 (Round) EDL-1500-4 (Square) White Reflector White Flange	EDL-1307-4 (Round) EDL-1505-4 (Square) Bronze Reflector Bronze Flange
---	--	--	---	---	--	--	--

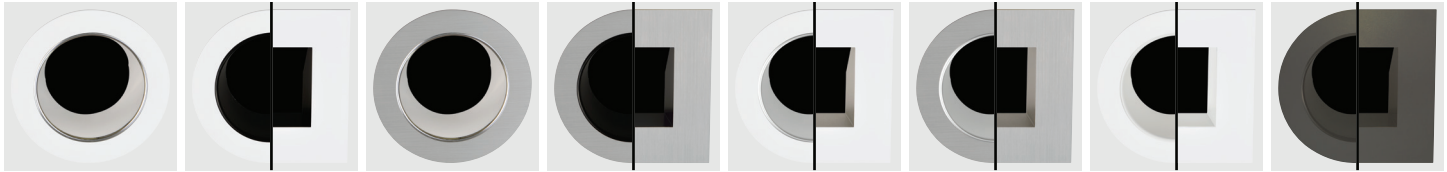

EDL-7000-4* White Reflector Trimless	EDL-7001-4* Satin Aluminum Reflector Trimless	EDL-7002-4* Bronze Reflector Trimless	EDL-7003-4* Black Alzak Reflector Trimless
--	---	---	--

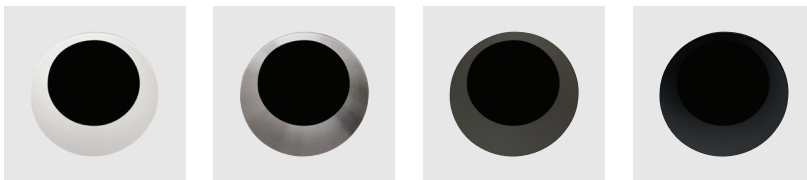

\* Trimless requires mud plate  
(EDL-RD-TR-4)

## Open Downlight

EDL-1000-4 Clear Alzak Reflector White Flange	EDL-1001-4 (Round) EDL-2001-4 (Square) Black Reflector White Flange	EDL-1002-4 Clear Alzak Reflector Satin Aluminum Flange	EDL-1003-4 (Round) EDL-2003-4 (Square) Black Reflector Satin Aluminum Flange	EDL-1004-4 (Round) EDL-2002-4 (Square) Haze Reflector White Flange	EDL-1005-4 (Round) EDL-2004-4 (Square) Haze Reflector Satin Aluminum Flange	EDL-1006-4 (Round) EDL-2000-4 (Square) White Reflector White Flange	EDL-1007-4 (Round) EDL-2005-4 (Square) Bronze Reflector Bronze Flange
---	--	--	---	---	--	--	--

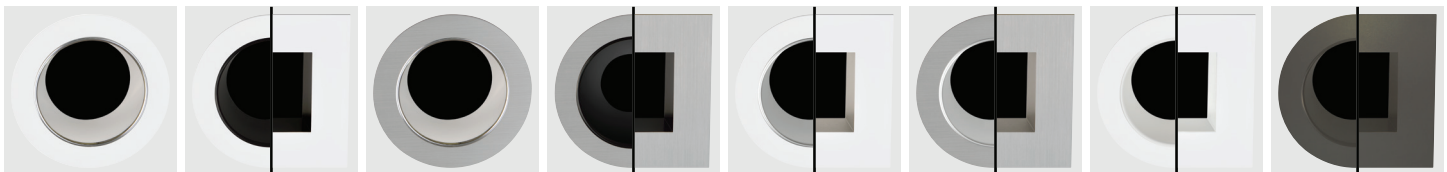

EDL-5000-4* White Reflector Trimless	EDL-5001-4* Satin Aluminum Reflector Trimless	EDL-5002-4* Bronze Reflector Trimless	EDL-5003-4* Black Alzak Reflector Trimless
--	---	---	--

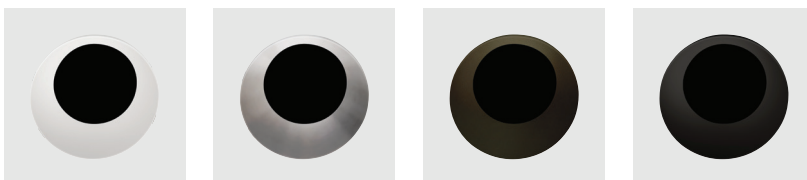

\* Trimless requires mud plate  
(EDL-RD-TR-4)

# 3" Eco-Downlight Trims

## Adjustable Baffle Downlight (Allows full adjustability)

EDL-1400-4 (Round) EDL-1600-4 (Square) White Baffle White Flange	EDL-1401-4 (Round) EDL-1601-4 (Square) Black Baffle White Flange	EDL-1402-4 (Round) EDL-1602-4 (Square) Black Baffle Satin Aluminum Flange	EDL-1403-4 (Round) EDL-1603-4 (Square) Bronze Baffle Bronze Flange
---	---	--	---

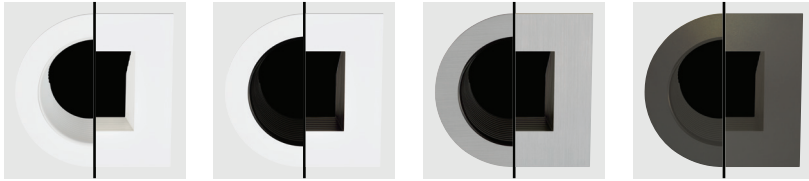

EDL-7100-4* White Baffle Trimless	EDL-7101-4* Satin Aluminum Baffle Trimless	EDL-7102-4* Bronze Baffle Trimless	EDL-7103-4* Black Baffle Trimless
---	--	--	---

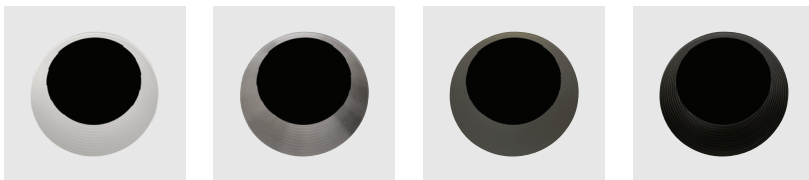

\* Trimless requires mud plate  
(EDL-RD-TR-4)

## Baffle Downlight

EDL-1100-4 (Round) EDL-2100-4 (Square) White Baffle White Flange	EDL-1101-4 (Round) EDL-2101-4 (Square) Black Baffle White Flange	EDL-1102-4 (Round) EDL-2102-4 (Square) Black Baffle Satin Aluminum Flange	EDL-1103-4 (Round) EDL-2103-4 (Square) Bronze Baffle Bronze Flange
---	---	--	---

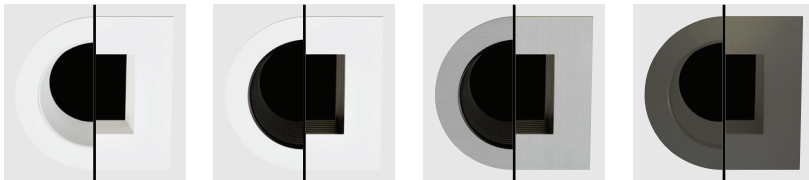

EDL-5100-4* White Baffle Trimless	EDL-5101-4* Satin Aluminum Baffle Trimless	EDL-5102-4* Bronze Baffle Trimless	EDL-5103-4* Black Baffle Trimless
---	--	--	---

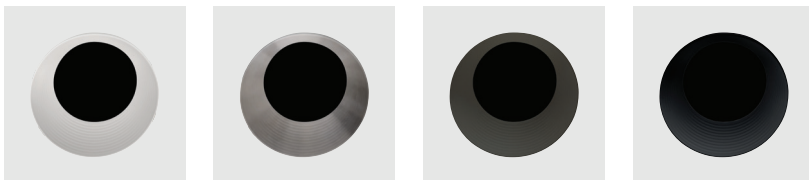

\* Trimless requires mud plate  
(EDL-RD-TR-4)

# 3" Eco-Downlight Trims

## Adjustable Shower Trim (Allows full adjustability)



## Shower Trim



## Wall Wash Trims

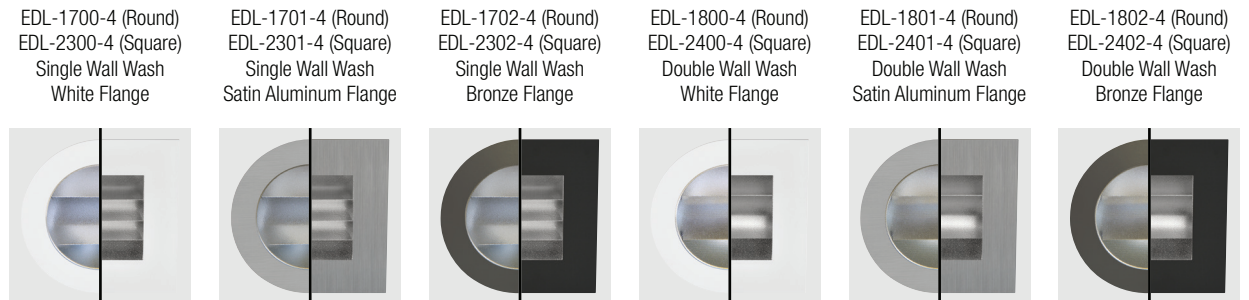

# 3" Eco-Downlight

## Shallow IC Air-Tight New Construction Housing

### Description

Shallow downlight housing delivers up to 1300lm through a 3" aperture with four optical distributions. Housing is designed to fit in shallow plenums with height of 2-1/2".

### Field Replaceable LED Light Engine

- 13W LED with 2700K, 3000K or 3500K @ 90 CRI with 2 SDCM binning

### Field Replaceable Dimming Drivers

- Remote Lutron Hi-lume® 2-Wire 1% 120V
- ERP, Universal Dim, 0-10V / ELV / Triac 10% 120-277V

### Optics

50° flood optic included (10°, 30° and 80° optic are available, must specify)

### Mounting

Includes (2) galvanized steel adjustable bar hangers for ceiling thicknesses up to 1"

### Trims

- Available in round or square aluminum trims, consult factory for custom finishes
- Available in open reflector, baffle, shower or wall wash trims
- Flush mount adapter and trimless mud plate available

### Emergency

Remote inverter operates for 90 minutes with remote test switch available, requires above ceiling access.

### Listing / Warranty

- Five (5) year limited warranty
- UL listed to US and Canadian standards for damp locations (Wet location when used with shower trim)
- Meets ASTM E283 standards



### Electrical Data

Wattage	CCT / CRI	Delivered Lumens	Efficacy
13W	2700K / 90 CRI	1000lm	77lpw
13W	3000K / 90 CRI	1200lm	92lpw
13W	3500K / 90 CRI	1300lm	100lpw

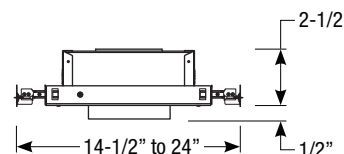
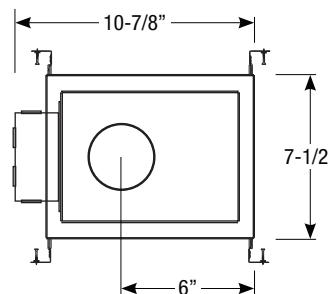
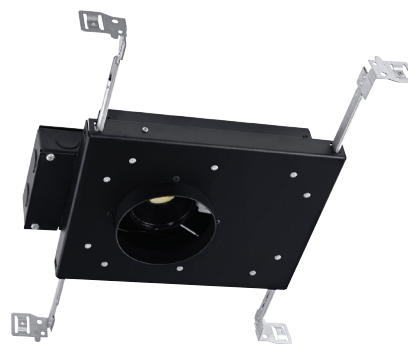

Field Cuttable  
Ceiling Cut-out: 3-7/8" Ø

### 13W Housing Order Matrix (Example: EDL-SIC-30-5-LR1)

CCT / CRI	Rev	Wattage / Driver
<b>EDL-SIC-27</b> (2700K / 90 CRI)	-5	(blank) (13W / ERP, Universal Dim, Triac/ELV/0-10V 10% 120-277V)
<b>EDL-SIC-30</b> (3000K / 90 CRI)		<b>-LR1</b> (13W / Remote Lutron Hi-lume® 2-Wire 1% 120V)
<b>EDL-SIC-35</b> (3500K / 90 CRI)		

### Optics

<b>EDL-10-OPTIC-5</b>	(10° Spot)
<b>EDL-30-OPTIC-4</b>	(30° Narrow Flood)
<b>EDL-50-OPTIC-4</b>	(50° Flood)
<b>EDL-80-OPTIC-4</b>	(80° Wide Flood)

### Housing Accessories

<b>EDL-MHLDR-4</b>	Media Holder - required for lenses
<b>EDL-FT-4</b>	Frosted Lens
<b>EDL-MP-4</b>	Solite Lens
<b>EDL-CL-4</b>	Clear Lens
<b>EDL-LN-4</b>	Linear Spread Lens

### Trim Accessories

<b>EDL-RD-TR-4</b>	Round Trimless Mud Plate
<b>EDL-RD-FMA</b>	Round Flush Mount Adapter
<b>EDL-SQ-FMA</b>	Square Flush Mount Adapter

### Emergency

<b>EM-1000</b>	(25W LED Remote Inverter)
<b>EM-1002</b>	(10W LED Remote Emergency Driver)
<b>EM-1003</b>	(35W LED Remote Inverter)
<b>EM-1004</b>	(50W LED Remote Inverter)



# 3" Eco-Downlight Trims

## Open Downlight

EDL-1000-4 Clear Alzak Reflector White Flange	EDL-1001-4 (Round) EDL-2001-4 (Square) Black Reflector White Flange	EDL-1002-4 Clear Alzak Reflector Satin Aluminum Flange	EDL-1003-4 (Round) EDL-2003-4 (Square) Black Reflector Satin Aluminum Flange	EDL-1004-4 (Round) EDL-2002-4 (Square) Haze Reflector White Flange	EDL-1005-4 (Round) EDL-2004-4 (Square) Haze Reflector Satin Aluminum Flange	EDL-1006-4 (Round) EDL-2000-4 (Square) White Reflector White Flange	EDL-1007-4 (Round) EDL-2005-4 (Square) Bronze Reflector Bronze Flange
---	--	--	---	---	--	--	--

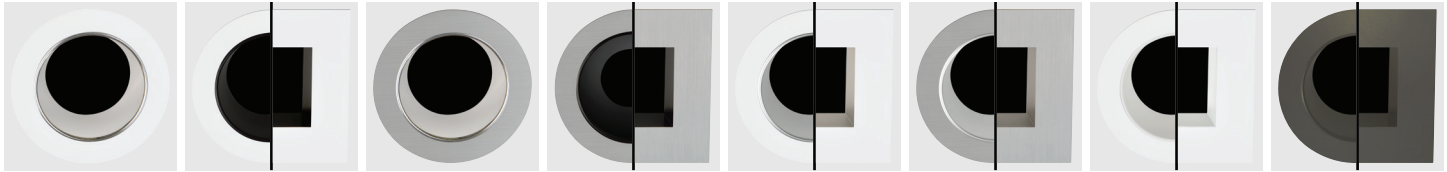

EDL-5000-4* White Reflector Trimless	EDL-5001-4* Satin Aluminum Reflector Trimless	EDL-5002-4* Bronze Reflector Trimless	EDL-5003-4* Black Alzak Reflector Trimless
--	---	---	--

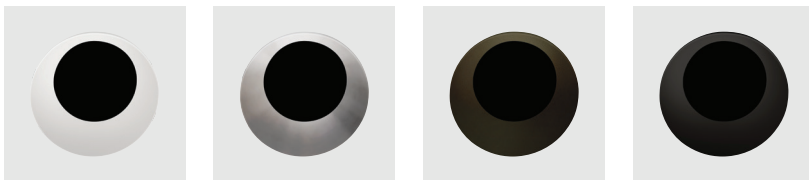

\* Trimless requires mud plate (EDL-RD-TR-4)

## Baffle Downlight

EDL-1100-4 (Round) EDL-2100-4 (Square) White Baffle White Flange	EDL-1101-4 (Round) EDL-2101-4 (Square) Black Baffle White Flange	EDL-1102-4 (Round) EDL-2102-4 (Square) Black Baffle Satin Aluminum Flange	EDL-1103-4 (Round) EDL-2103-4 (Square) Bronze Baffle Bronze Flange
---	---	--	---

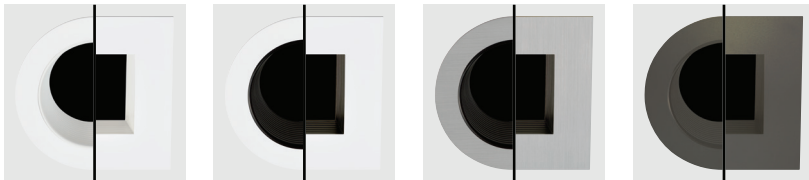

EDL-5100-4* White Baffle Trimless	EDL-5101-4* Satin Aluminum Baffle Trimless	EDL-5102-4* Bronze Baffle Trimless	EDL-5103-4* Black Baffle Trimless
---	--	--	---

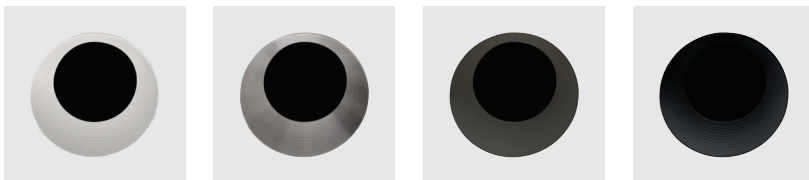

\* Trimless requires mud plate (EDL-RD-TR-4)

# 3" Eco-Downlight Trims

## Shower Trim

EDL-1200-4  
White Flange



EDL-1201-4  
Satin Aluminum Flange



EDL-2200-4  
White Flange



EDL-2201-4  
Satin Aluminum Flange



## Wall Wash Trims

EDL-1700-4 (Round)  
EDL-2300-4 (Square)  
Single Wall Wash  
White Flange

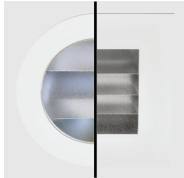

EDL-1701-4 (Round)  
EDL-2301-4 (Square)  
Single Wall Wash  
Satin Aluminum Flange

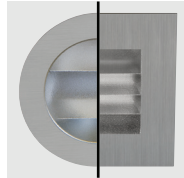

EDL-1702-4 (Round)  
EDL-2302-4 (Square)  
Single Wall Wash  
Bronze Flange

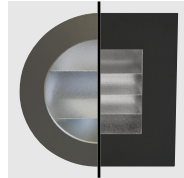

EDL-1800-4 (Round)  
EDL-2400-4 (Square)  
Double Wall Wash  
White Flange



EDL-1801-4 (Round)  
EDL-2401-4 (Square)  
Double Wall Wash  
Satin Aluminum Flange



EDL-1802-4 (Round)  
EDL-2402-4 (Square)  
Double Wall Wash  
Bronze Flange

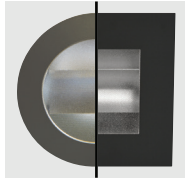

# 3" Eco-Downlight

## Non-IC New Construction Housing

### Description

Downlight housing delivers up to 2000lm through a 3" aperture with four optical distributions. New construction housing is rated for non insulated ceilings.

### Field Replaceable LED Light Engine

- 13W LED with 2700K or 3000K @ 90 CRI with 2 SDCM binning
- 21W LED with 2700K, 3000K or 3500K @ 90 CRI with 2 SDCM binning

### Field Replaceable Dimming Driver

- 13W Low power density (LPD) housings include an universal ELV / Triac driver with 120-277V input
- 21W housings are available with remote Lutron Hi-lume® or universal 0-10V / ELV / Triac driver

### Optics

50° flood optic included (10°, 30° and 80° optic are available, must specify)

### Mounting

- Tension clips allow housing to adjust vertically for ceiling thicknesses from 1/2" to 1"
- Requires a minimum ceiling depth of 7"

### Gasket for IC Installations

13W Low power density (LPD) housings are available with IC Air-Tight gasket, must specify EDL-AT-GSKT.

### Trims

- Available in round or square aluminum trims, consult factory for custom finishes
- Available in open reflector, baffle, shower or wall wash trims
- Flush mount adapter available

### Emergency

Remote inverter operates for 90 minutes with remote test switch available, requires above ceiling access.

### Listing / Warranty

- Five (5) year limited warranty
- UL listed to US and Canadian standards for damp locations (Wet location when used with shower trim)



### LPD 13W Housing Order Matrix (Example: EDL-NC-30-5-LPD)

CCT / CRI	Rev	Wattage / Driver
<b>EDL-NC-27</b> (2700K / 90 CRI) <b>EDL-NC-30</b> (3000K / 90 CRI)	-5	-LPD (13W / ERP, Universal Dim, Triac/ELV 10% 120-277V)

### Standard 21W Housing Order Matrix (Example: EDL-NC-30-5-LR1)

CCT / CRI	Rev	Wattage / Driver
<b>EDL-NC-27</b> (2700K / 90 CRI) <b>EDL-NC-30</b> (3000K / 90 CRI) <b>EDL-NC-35</b> (3500K / 90 CRI)	-5	(blank) (21W / ERP, Universal Dim, Triac/ELV/0-10V 10% 120-277V) -LR1 (21W / Remote Lutron Hi-lume® 2-Wire 1% 120V)

### Electrical Data

Wattage	CCT / CRI	Delivered Lumens	Efficacy
13W	2700K / 90 CRI	1000lm	77lpw
13W	3000K / 90 CRI	1200lm	92lpw
21W	2700K / 90 CRI	1700lm	81lpw
21W	3000K / 90 CRI	1850lm	88lpw
21W	3500K / 90 CRI	2000lm	95lpw

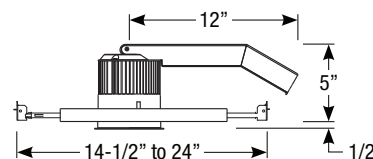
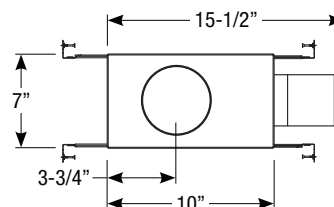

Field Cuttable  
Ceiling Cut-out: 3-7/8" Ø

### Housing Accessories

<b>EDL-AT-GSKT</b>	Air-Tight IC Gasket for LPD housing
<b>EDL-MHLDR-4</b>	Media Holder - required for lenses
<b>EDL-FT-4</b>	Frosted Lens
<b>EDL-MP-4</b>	Solite Lens
<b>EDL-CL-4</b>	Clear Lens
<b>EDL-LN-4</b>	Linear Spread Lens

### Trim Accessories

<b>EDL-RD-FMA</b>	Round Flush Mount Adapter
<b>EDL-SQ-FMA</b>	Square Flush Mount Adapter

### Optics

<b>EDL-10-OPTIC-5</b>	(10° Spot)
<b>EDL-30-OPTIC-4</b>	(30° Narrow Flood)
<b>EDL-50-OPTIC-4</b>	(50° Flood)
<b>EDL-80-OPTIC-4</b>	(80° Wide Flood)

### Emergency

<b>EM-1000</b>	(25W LED Remote Inverter)
<b>EM-1002</b>	(10W LED Remote Emergency Driver)
<b>EM-1003</b>	(35W LED Remote Inverter)
<b>EM-1004</b>	(50W LED Remote Inverter)



# 3" Eco-Downlight Trims

## Open Downlight

- EDL-1000-4  
Clear Alzak Reflector  
White Flange
- EDL-1001-4 (Round)  
EDL-2001-4 (Square)  
Black Reflector  
White Flange
- EDL-1002-4  
Clear Alzak Reflector  
Satin Aluminum Flange
- EDL-1003-4 (Round)  
EDL-2003-4 (Square)  
Black Reflector  
Satin Aluminum Flange
- EDL-1004-4 (Round)  
EDL-2002-4 (Square)  
Haze Reflector  
White Flange
- EDL-1005-4 (Round)  
EDL-2004-4 (Square)  
Haze Reflector  
Satin Aluminum Flange
- EDL-1006-4 (Round)  
EDL-2000-4 (Square)  
White Reflector  
White Flange
- EDL-1007-4 (Round)  
EDL-2005-4 (Square)  
Bronze Reflector  
Bronze Flange

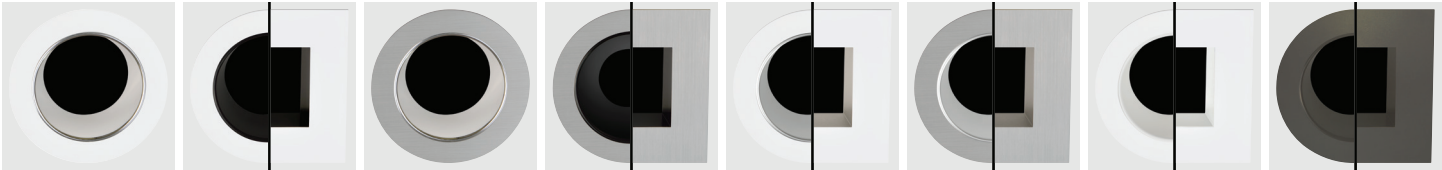

## Baffle Downlight

- EDL-1100-4 (Round)  
EDL-2100-4 (Square)  
White Baffle  
White Flange
- EDL-1101-4 (Round)  
EDL-2101-4 (Square)  
Black Baffle  
White Flange
- EDL-1102-4 (Round)  
EDL-2102-4 (Square)  
Black Baffle  
Satin Aluminum Flange
- EDL-1103-4 (Round)  
EDL-2103-4 (Square)  
Bronze Baffle  
Bronze Flange

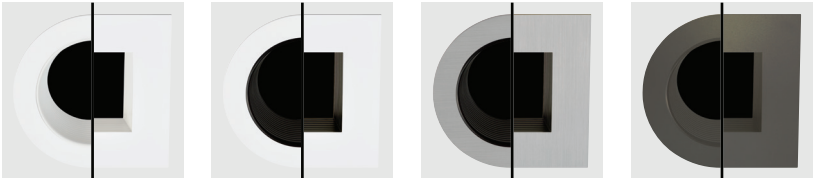

## Shower Trim

- EDL-1200-4  
White Flange
- EDL-1201-4  
Satin Aluminum Flange
- EDL-2200-4  
White Flange
- EDL-2201-4  
Satin Aluminum Flange



## Wall Wash Trims

- EDL-1700-4 (Round)  
EDL-2300-4 (Square)  
Single Wall Wash  
White Flange
- EDL-1701-4 (Round)  
EDL-2301-4 (Square)  
Single Wall Wash  
Satin Aluminum Flange
- EDL-1702-4 (Round)  
EDL-2302-4 (Square)  
Single Wall Wash  
Bronze Flange
- EDL-1800-4 (Round)  
EDL-2400-4 (Square)  
Double Wall Wash  
White Flange
- EDL-1801-4 (Round)  
EDL-2401-4 (Square)  
Double Wall Wash  
Satin Aluminum Flange
- EDL-1802-4 (Round)  
EDL-2402-4 (Square)  
Double Wall Wash  
Bronze Flange

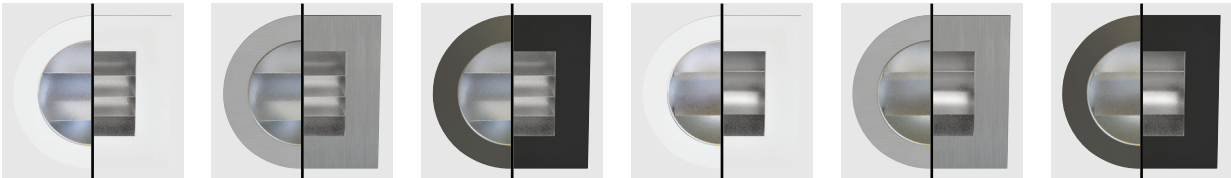

## 3" Eco-Downlight Non-IC Remodel Housing

### Description

Downlight housing delivers up to 2000lm through a 3" aperture with four optical distributions. Remodel housing is rated for non insulated ceilings.

### Field Replaceable LED Light Engine

- 13W LED with 2700K or 3000K @ 90 CRI with 2 SDCM binning
- 21W LED with 2700K, 3000K or 3500K @ 90 CRI with 2 SDCM binning

### Field Replaceable Dimming Driver

- 13W Low power density (LPD) housings include an universal ELV / Triac driver with 120-277V input
- 21W housings are available with remote Lutron Hi-lume® or universal 0-10V / ELV / Triac driver

### Optics

50° flood optic included (10°, 30° and 80° optic are available, must specify)

### Mounting

- Tension clips allow housing to adjust vertically for ceiling thicknesses from 1/2" to 1"
- Requires a minimum ceiling depth of 7"

### Gasket for IC Installations

13W Low power density (LPD) housings are available with IC Air-Tight gasket, must specify EDL-AT-GSKT.

### Trims

- Available in round or square aluminum trims, consult factory for custom finishes
- Available in open reflector, baffle, shower or wall wash trims
- Flush mount adapter available

### Emergency

Remote inverter operates for 90 minutes with remote test switch available, requires above ceiling access.

### Listing / Warranty

- Five (5) year limited warranty
- UL listed to US and Canadian standards for damp locations (Wet location when used with shower trim)



### LPD 13W Housing Order Matrix (Example: EDL-RM-30-5-LPD)

CCT / CRI	Rev	Wattage / Driver
<b>EDL-RM-27</b> (2700K / 90 CRI) <b>EDL-RM-30</b> (3000K / 90 CRI)	-5	-LPD (13W / ERP, Universal Dim, Triac/ELV 10% 120-277V)

### Standard 21W Housing Order Matrix (Example: EDL-RM-30-5-LR1)

CCT / CRI	Rev	Wattage / Driver
<b>EDL-RM-27</b> (2700K / 90 CRI) <b>EDL-RM-30</b> (3000K / 90 CRI) <b>EDL-RM-35</b> (3500K / 90 CRI)	-5	(blank) (21W / ERP, Universal Dim, Triac/ELV/0-10V 10% 120-277V) -LR1 (21W / Remote Lutron Hi-lume® 2-Wire 1% 120V)

### Electrical Data

Wattage	CCT / CRI	Delivered Lumens	Efficacy
13W	2700K / 90 CRI	1000lm	77lpw
13W	3000K / 90 CRI	1200lm	92lpw
21W	2700K / 90 CRI	1700lm	81lpw
21W	3000K / 90 CRI	1850lm	88lpw
21W	3500K / 90 CRI	2000lm	95lpw

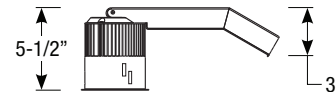
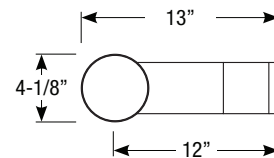

Ceiling Cut-out: 3-3/4" Ø

### Housing Accessories

<b>EDL-AT-GSKT</b>	Air-Tight IC Gasket for LPD housing
<b>EDL-MHLDR-4</b>	Media Holder - required for lenses
<b>EDL-FT-4</b>	Frosted Lens
<b>EDL-MP-4</b>	Solite Lens
<b>EDL-CL-4</b>	Clear Lens
<b>EDL-LN-4</b>	Linear Spread Lens

### Trim Accessories

<b>EDL-RD-FMA</b>	Round Flush Mount Adapter
<b>EDL-SQ-FMA</b>	Square Flush Mount Adapter

### Optics

<b>EDL-10-OPTIC-5</b>	(10° Spot)
<b>EDL-30-OPTIC-4</b>	(30° Narrow Flood)
<b>EDL-50-OPTIC-4</b>	(50° Flood)
<b>EDL-80-OPTIC-4</b>	(80° Wide Flood)

### Emergency

<b>EM-1000</b>	(25W LED Remote Inverter)
<b>EM-1002</b>	(10W LED Remote Emergency Driver)
<b>EM-1003</b>	(35W LED Remote Inverter)
<b>EM-1004</b>	(50W LED Remote Inverter)

# 3" Eco-Downlight Trims

## Open Downlight

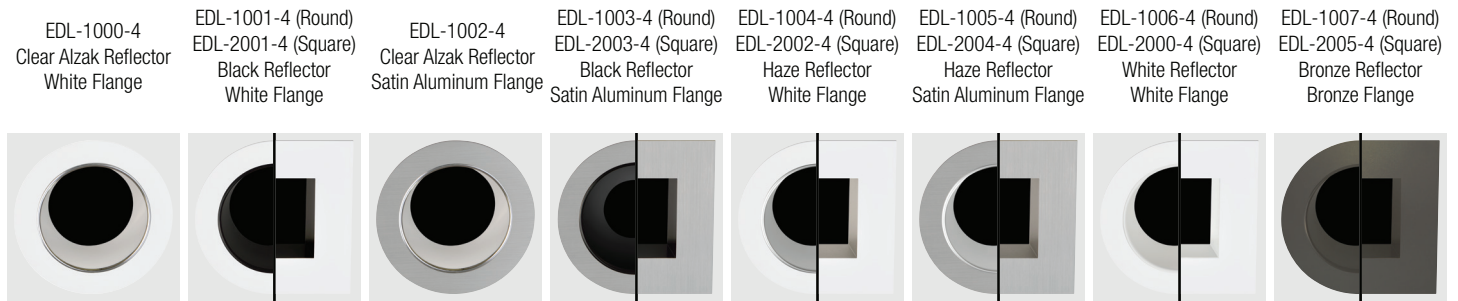

## Baffle Downlight

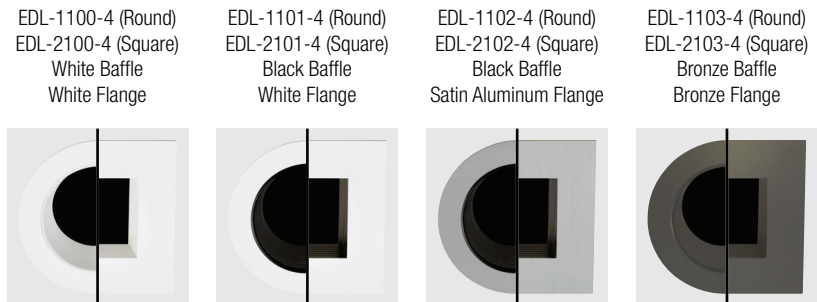

## Shower Trim



## Wall Wash Trims

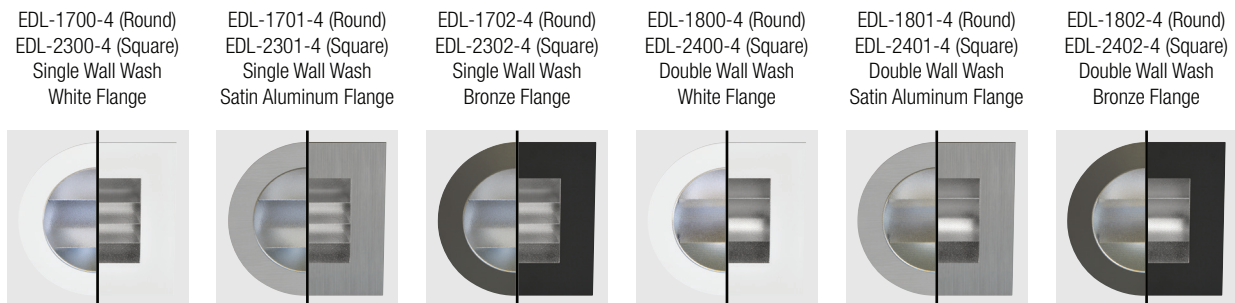

# 5" Eco-Downlight

## IC Air-Tight New Construction Housing

### Description

New construction housing delivers up to 2500lm through a 5" aperture with four optical distributions. Air-tight housing is rated for direct contact with insulation.

### Field Replaceable LED Light Engine

- 17W LED with 2700K or 3000K @ 90 CRI with 2 SDCM binning
- 30W LED with 2700K, 3000K or 3500K @ 90 CRI with 2 SDCM binning

### Field Replaceable Dimming Driver

- 17W Low power density (LPD) housings include an universal ELV / Triac driver with 120-277V input
- 30W housings are available with remote Lutron Hi-lume® or universal 0-10V / ELV / Triac driver

### Optics

50° flood optic included (10°, 30° and 80° optic are available, must specify)

### Mounting

Includes (2) galvanized steel adjustable bar hangers for ceiling thicknesses up to 1"

### Trims

- Available in round or square aluminum trims, consult factory for custom finishes
- Available in open reflector, baffle, shower or wall wash trims
- Flush mount adapter and trimless mud plate available

### Emergency

Remote inverter operates for 90 minutes with remote test switch available, requires above ceiling access.

### Listing / Warranty

- Five (5) year limited warranty
- UL listed to US and Canadian standards for damp locations (Wet location when used with shower trim)
- Meets ASTM E283 standards



### Electrical Data

Wattage	CCT / CRI	Delivered Lumens	Efficacy
17W	2700K / 90 CRI	1450lm	85lpw
17W	3000K / 90 CRI	1550lm	91lpw
30W	2700K / 90 CRI	2200lm	73lpw
30W	3000K / 90 CRI	2350lm	78lpw
30W	3500K / 90 CRI	2500lm	83lpw

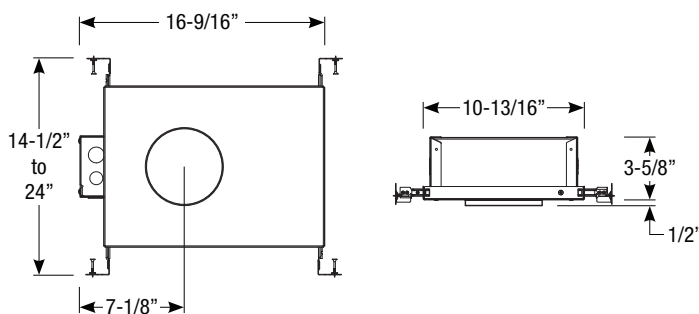

Field Cuttable  
Ceiling Cut-out: 5-1/8" Ø

### Housing Accessories

<b>EDL5-MHLDR-1</b>	Media Holder - required for lenses
<b>EDL5-FT-1</b>	Frosted Lens
<b>EDL5-MP-1</b>	Solite Lens
<b>EDL5-CL-1</b>	Clear Lens
<b>EDL5-LN-1</b>	Linear Spread Lens

### Trim Accessories

<b>EDL5-RD-TR-1</b>	Round Trimless Mud Plate
<b>EDL5-RD-FMA</b>	Round Flush Mount Adapter
<b>EDL5-SQ-FMA</b>	Square Flush Mount Adapter

### Optics

<b>EDL5-10-OPTIC-2</b>	(10° Spot)
<b>EDL5-30-OPTIC-1</b>	(30° Narrow Flood)
<b>EDL5-50-OPTIC-1</b>	(50° Flood)
<b>EDL5-80-OPTIC-1</b>	(80° Wide Flood)

### Emergency

<b>EM-1000</b>	(25W LED Remote Inverter)
<b>EM-1002</b>	(10W LED Remote Emergency Driver)
<b>EM-1003</b>	(35W LED Remote Inverter)
<b>EM-1004</b>	(50W LED Remote Inverter)

### LPD 17W Housing Order Matrix (Example: EDL5-ADJ-30-2-LPD)

CCT / CRI	Rev	Wattage / Driver
<b>EDL5-ADJ-27</b> (2700K / 90 CRI)	<b>-2</b>	<b>-LPD</b> (17W / ERP, Universal Dim, Triac/ELV 10% 120-277V)
<b>EDL5-ADJ-30</b> (3000K / 90 CRI)		

### Standard 30W Housing Order Matrix (Example: EDL5-ADJ-30-2-LR1)

CCT / CRI	Rev	Wattage / Driver
<b>EDL5-ADJ-27</b> (2700K / 90 CRI)	<b>-2</b>	(blank) (30W / ERP, Universal Dim, Triac/ELV/0-10V 10% 120-277V)
<b>EDL5-ADJ-30</b> (3000K / 90 CRI)		
<b>EDL5-ADJ-35</b> (3500K / 90 CRI)		



# 5" Eco-Downlight Trims

## Open Reflector

EDL5-1000-1  
Clear Alzak Reflector  
White Flange



EDL5-1001-1  
Black Alzak Reflector  
White Flange

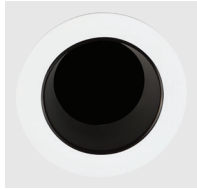

EDL5-1002-1  
Clear Alzak Reflector  
Satin Aluminum Flange

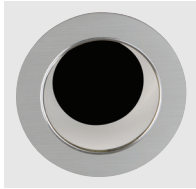

EDL5-1003-1  
Black Alzak Reflector  
Satin Aluminum Flange

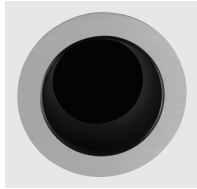

EDL5-1004-1  
Haze Reflector  
White Flange

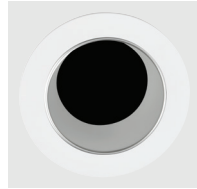

EDL5-1005-1  
Haze Reflector  
Satin Aluminum Flange

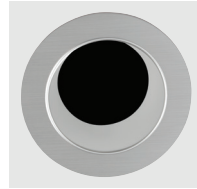

EDL5-1006-1  
White Reflector  
White Flange

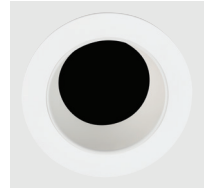

EDL5-5000-1\*  
White Reflector  
Trimless

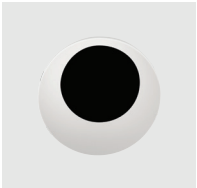

EDL5-5001-1\*  
Satin Aluminum Reflector  
Trimless

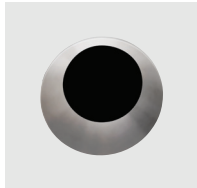

EDL5-5002-1\*  
Bronze Reflector  
Trimless

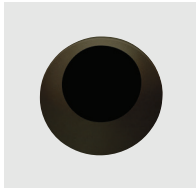

EDL5-5003-1\*  
Black Alzak Reflector  
Trimless

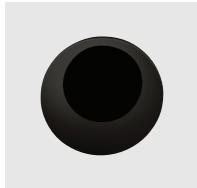

\* Trimless requires mud plate  
(EDL5-RD-TR-1)

EDL5-2000-1  
White Reflector  
White Flange

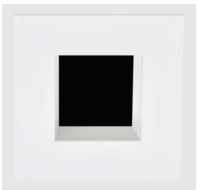

EDL5-2001-1  
Black Reflector  
White Flange

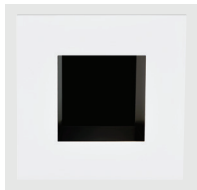

EDL5-2002-1  
Haze Reflector  
White Flange

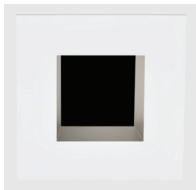

EDL5-2003-1  
Black Reflector  
Satin Aluminum Flange

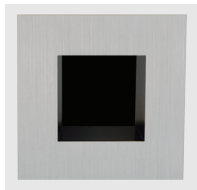

EDL5-2004-1  
Haze Reflector  
Satin Aluminum Flange

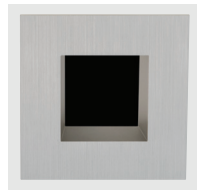

## Shower Trim

EDL5-1200-1  
White Flange



EDL5-1201-1  
Satin Aluminum Flange



EDL5-2200-1  
White Flange



EDL5-2201-1  
Satin Aluminum Flange



# 5" Eco-Downlight Trims

## Baffle Downlight

EDL5-1100-1  
White Baffle  
White Flange



EDL5-1101-1  
Black Baffle  
White Flange



EDL5-1102-1  
Black Baffle  
Satin Aluminum Flange

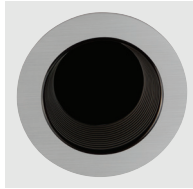

EDL5-5100-1  
White Baffle  
Trimless

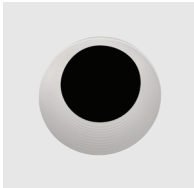

EDL5-5101-1  
Satin Aluminum Baffle  
Trimless



EDL5-5102-1  
Bronze Baffle  
Trimless

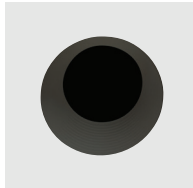

EDL5-5103-1  
Black Baffle  
Trimless

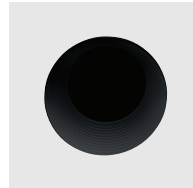

\* Trimless requires mud plate  
(EDL5-RD-TR-1)

EDL5-2100-1  
White Baffle  
White Flange

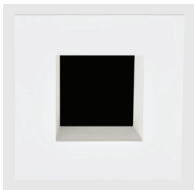

EDL5-2101-1  
Black Baffle  
White Flange



EDL5-2102-1  
Black Baffle  
Satin Aluminum Flange



## Wall Wash Trim

EDL5-1700-1  
Single Wall Wash  
White Flange

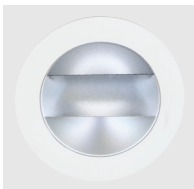

EDL5-1701-1  
Single Wall Wash  
Satin Aluminum Flange

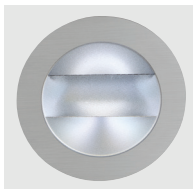

EDL5-1702-1  
Single Wall Wash  
Bronze Flange

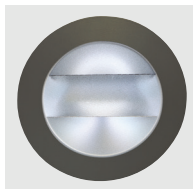

EDL5-1800-1  
Double Wall Wash  
White Flange

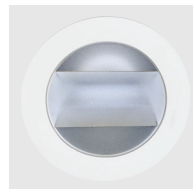

EDL5-1801-1  
Double Wall Wash  
Satin Aluminum Flange

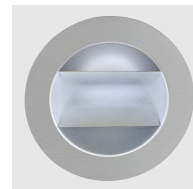

EDL5-1802-1  
Double Wall Wash  
Bronze Flange

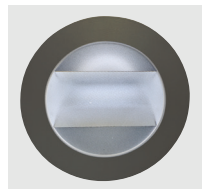

EDL5-2300-1  
Single Wall Wash  
White Flange



EDL5-2301-1  
Single Wall Wash  
Satin Aluminum Flange

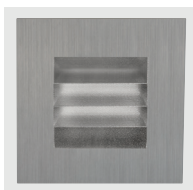

EDL5-2400-1  
Double Wall Wash  
White Flange



EDL5-2401-1  
Double Wall Wash  
Satin Aluminum Flange



## 5" Eco-Downlight IC Air-Tight New Construction Housing

### Description

Adjustable housing delivers up to 2500lm through a 5" aperture with four optical distributions. New construction housing is rated for non insulated ceilings and adjustable mechanism allows for precise aiming up to 45° tilt and 359° rotation.

### Field Replaceable LED Light Engine

- 17W LED with 2700K or 3000K @ 90 CRI with 2 SDCM binning
- 30W LED with 2700K, 3000K or 3500K @ 90 CRI with 2 SDCM binning

### Field Replaceable Dimming Driver

- 17W Low power density (LPD) housings include an universal ELV / Triac driver with 120-277V input
- 30W housings are available with remote Lutron Hi-lume® or universal 0-10V / ELV / Triac driver

### Optics

50° flood optic included (10°, 30° and 80° optic are available, must specify)

### Mounting

Includes (2) galvanized steel adjustable bar hangers for ceiling thicknesses up to 1"

### Adjustability

359° horizontal rotation / Up to 45° vertical tilt

### Trims

- Available in round or square aluminum trims, consult factory for custom finishes
- Available in open reflector, baffle, shower or wall wash trims
- Flush mount adapter and trimless mud plate available

### Emergency

Remote inverter operates for 90 minutes with remote test switch available, requires above ceiling access.

### Listing / Warranty

- Five (5) year limited warranty
- UL listed to US and Canadian standards for damp locations (Wet location when used with shower trim)



### Electrical Data

Wattage	CCT / CRI	Delivered Lumens	Efficacy
17W	2700K / 90 CRI	1450lm	85lpw
17W	3000K / 90 CRI	1550lm	91lpw
30W	2700K / 90 CRI	2200lm	73lpw
30W	3000K / 90 CRI	2350lm	78lpw
30W	3500K / 90 CRI	2500lm	83lpw

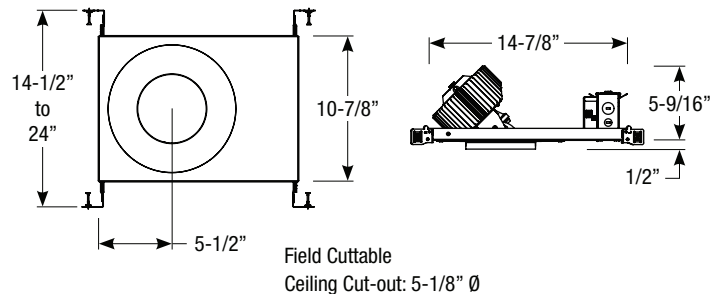
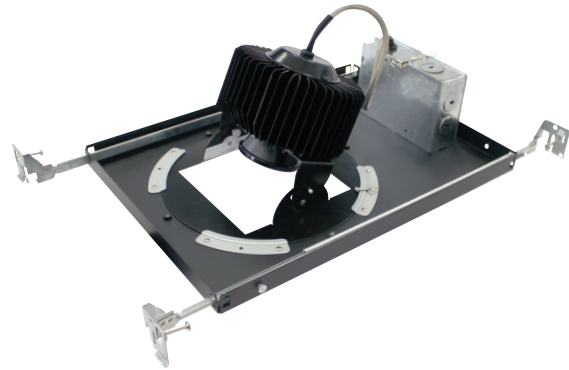

### Housing Accessories

<b>EDL5-MHLDR-1</b>	Media Holder - required for lenses
<b>EDL5-FT-1</b>	Frosted Lens
<b>EDL5-MP-1</b>	Solite Lens
<b>EDL5-CL-1</b>	Clear Lens
<b>EDL5-LN-1</b>	Linear Spread Lens

### Trim Accessories

<b>EDL5-RD-TR-1</b>	Round Trimless Mud Plate
<b>EDL5-RD-FMA</b>	Round Flush Mount Adapter
<b>EDL5-SQ-FMA</b>	Square Flush Mount Adapter

### Optics

<b>EDL5-10-OPTIC-2</b>	(10° Spot)
<b>EDL5-30-OPTIC-1</b>	(30° Narrow Flood)
<b>EDL5-50-OPTIC-1</b>	(50° Flood)
<b>EDL5-80-OPTIC-1</b>	(80° Wide Flood)

### Emergency

<b>EM-1000</b>	(25W LED Remote Inverter)
<b>EM-1002</b>	(10W LED Remote Emergency Driver)
<b>EM-1003</b>	(35W LED Remote Inverter)
<b>EM-1004</b>	(50W LED Remote Inverter)

### LPD 17W Housing Order Matrix (Example: EDL5-NCADJ-30-2-LPD)

CCT / CRI	Rev	Wattage / Driver
<b>EDL5-NCADJ-27</b> (2700K / 90 CRI) <b>EDL5-NCADJ-30</b> (3000K / 90 CRI)	-2	-LPD (17W / ERP, Universal Dim, Triac/ELV 10% 120-277V)

### Standard 30W Housing Order Matrix (Example: EDL5-NCADJ-30-2-LR1)

CCT / CRI	Rev	Wattage / Driver
<b>EDL5-NCADJ-27</b> (2700K / 90 CRI) <b>EDL5-NCADJ-30</b> (3000K / 90 CRI) <b>EDL5-NCADJ-35</b> (3500K / 90 CRI)	-2	(blank) (30W / ERP, Universal Dim, Triac/ELV/0-10V 10% 120-277V) -LR1 (30W / Remote Lutron Hi-lume® 2-Wire 1% 120V)



# 5" Eco-Downlight Trims

### Adjustable Accent Reflector (Allows full adjustability)

EDL5-1300-1 Clear Alzak Reflector White Flange	EDL5-1301-1 (Round) EDL5-1501-1 (Square) Black Reflector White Flange	EDL5-1302-1 Clear Alzak Reflector Satin Aluminum Flange	EDL5-1303-1 (Round) EDL5-1503-1 (Square) Black Reflector Satin Aluminum Flange	EDL5-1304-1 (Round) EDL5-1502-1 (Square) Haze Reflector White Flange	EDL5-1305-1 (Round) EDL5-1504-1 (Square) Haze Reflector Satin Aluminum Flange	EDL5-1306-1 (Round) EDL5-1500-1 (Square) White Reflector White Flange	EDL5-1307-1 (Round) EDL5-1505-1 (Square) Bronze Reflector Bronze Flange
--	--	---	---	---	--	--	--

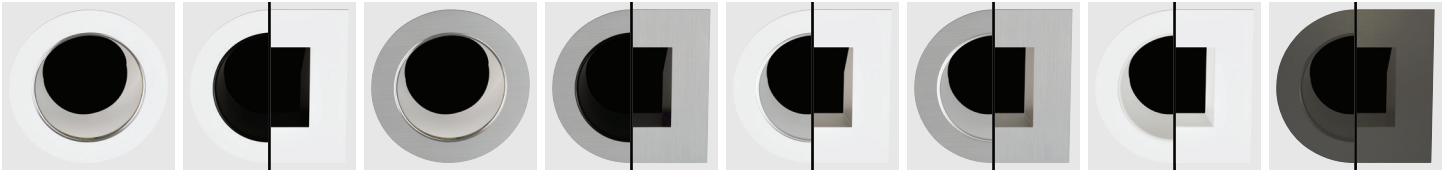

EDL5-7000-1* White Reflector Trimless	EDL5-7001-1* Satin Aluminum Reflector Trimless	EDL5-7002-1* Bronze Reflector Trimless	EDL5-7003-1* Black Alzak Reflector Trimless
---	--	--	---

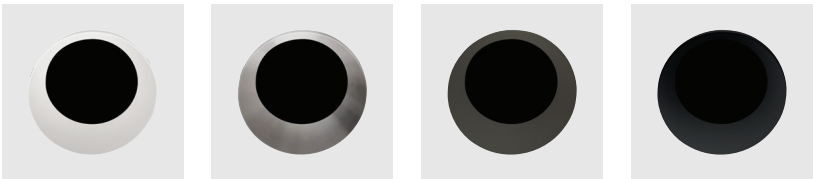

\* Trimless requires mud plate (EDL5-RD-TR-1)

### Open Reflector

EDL5-1000-1 Clear Alzak Reflector White Flange	EDL5-1001-1 (Round) EDL5-2001-1 (Square) Black Alzak Reflector White Flange	EDL5-1002-1 Clear Alzak Reflector Satin Aluminum Flange	EDL5-1003-1 (Round) EDL5-2003-1 (Square) Black Reflector Satin Aluminum Flange	EDL5-1004-1 (Round) EDL5-2002-1 (Square) Haze Reflector White Flange	EDL5-1005-1 (Round) EDL5-2004-1 (Square) Haze Reflector Satin Aluminum Flange	EDL5-1006-1 (Round) EDL5-2000-1 (Square) White Reflector White Flange
--	--	---	---	---	--	--

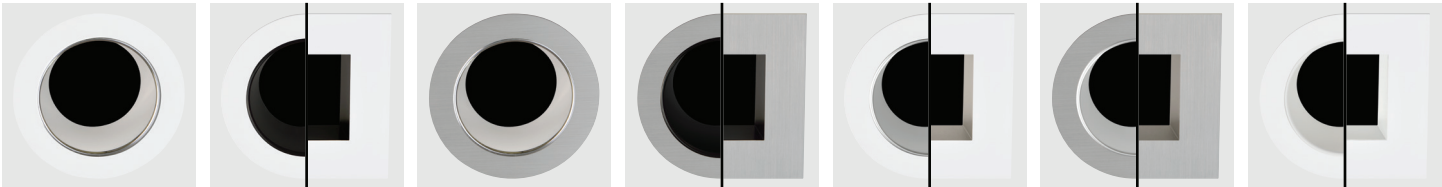

EDL5-5000-1* White Reflector Trimless	EDL5-5001-1* Satin Aluminum Reflector Trimless	EDL5-5002-1* Bronze Reflector Trimless	EDL5-5003-1* Black Alzak Reflector Trimless
---	--	--	---

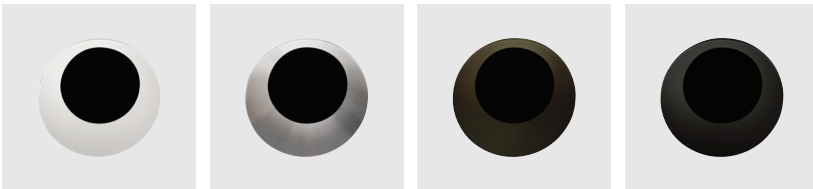

\* Trimless requires mud plate (EDL5-RD-TR-1)

## 5" Eco-Downlight Trims

### Adjustable Baffle Downlight (Allows full adjustability)

EDL5-1400-1 (Round) EDL5-1600-1 (Square) White Baffle White Flange	EDL5-1401-1 (Round) EDL5-1601-1 (Square) Black Baffle White Flange	EDL5-1402-1 (Round) EDL5-1602-1 (Square) Black Baffle Satin Aluminum Flange	EDL5-1403-1 (Round) EDL5-1603-1 (Square) Bronze Baffle Bronze Flange
---	---	--	---

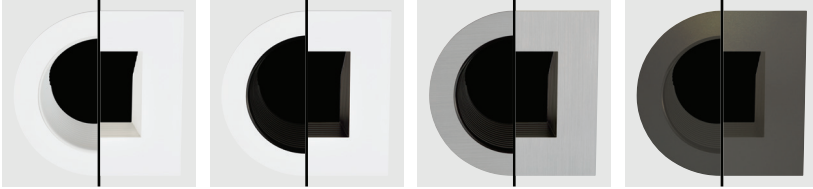

EDL5-7100-1* White Baffle Trimless	EDL5-7101-1* Satin Aluminum Baffle Trimless	EDL5-7102-1* Bronze Baffle Trimless	EDL5-7103-1* Black Baffle Trimless
--	---	---	--

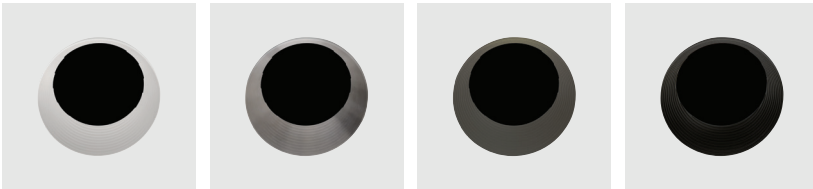

\* Trimless requires mud plate  
(EDL5-RD-TR-1)

### Baffle Downlight

EDL5-1100-1 (Round) EDL5-2100-1 (Square) White Baffle White Flange	EDL5-1101-1 (Round) EDL5-2101-1 (Square) Black Baffle White Flange	EDL5-1102-1 (Round) EDL5-2102-1 (Square) Black Baffle Satin Aluminum Flange
---	---	--

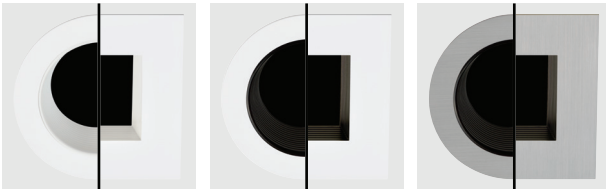

EDL5-5100-1 White Baffle Trimless	EDL5-5101-1 Satin Aluminum Baffle Trimless	EDL5-5102-1 Bronze Baffle Trimless	EDL5-5103-1 Black Baffle Trimless
---	--	--	---

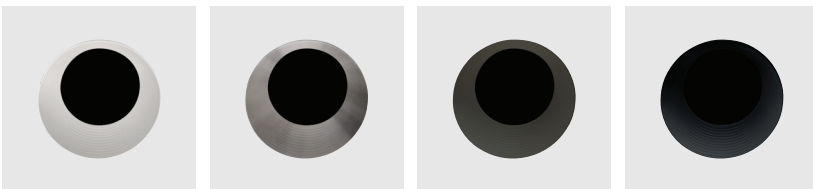

\* Trimless requires mud plate  
(EDL5-RD-TR-1)

# 5" Eco-Downlight Trims

## Shower Trim

EDL5-1200-1  
White Flange



EDL5-1201-1  
Satin Aluminum Flange



EDL5-2200-1  
White Flange



EDL5-2201-1  
Satin Aluminum Flange



## Wall Wash Trim

EDL5-1700-1  
Single Wall Wash  
White Flange



EDL5-1701-1  
Single Wall Wash  
Satin Aluminum Flange

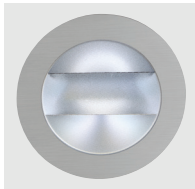

EDL5-1702-1  
Single Wall Wash  
Bronze Flange

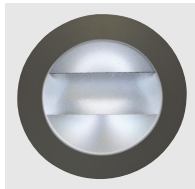

EDL5-1800-1  
Double Wall Wash  
White Flange

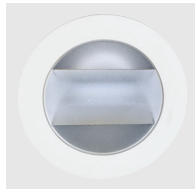

EDL5-1801-1  
Double Wall Wash  
Satin Aluminum Flange

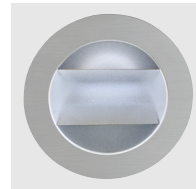

EDL5-1802-1  
Double Wall Wash  
Bronze Flange

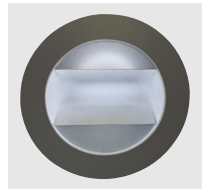

EDL5-2300-1  
Single Wall Wash  
White Flange



EDL5-2301-1  
Single Wall Wash  
Satin Aluminum Flange

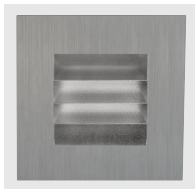

EDL5-2400-1  
Double Wall Wash  
White Flange



EDL5-2401-1  
Double Wall Wash  
Satin Aluminum Flange



## 5" Eco-Downlight Non-IC New Construction Housing

### Description

Downlight housing delivers up to 2500lm through a 5" aperture with three optical distributions. New construction housing is rated for non insulated ceilings.

### Field Replaceable LED Light Engine

- 17W LED with 2700K or 3000K @ 90 CRI with 2 SDCM binning
- 30W LED with 2700K, 3000K or 3500K @ 90 CRI with 2 SDCM binning

### Field Replaceable Dimming Driver

- 17W Low power density (LPD) housings include an universal ELV / Triac driver with 120-277V input
- 30W housings are available with remote Lutron Hi-lume® or universal 0-10V / ELV / Triac driver

### Optics

50° flood optic included (30° and 80° optic are available, must specify)

### Mounting

- Tension clips allow housing to adjust vertically for ceiling thicknesses from 1/2" to 1-1/2"
- Requires a minimum ceiling depth of 7"

### Gasket for IC Installations

17W Low power density (LPD) housings are available with IC Air-Tight gasket, must specify EDL5-AT-GSKT.

### Trims

- Available in round or square aluminum trims, consult factory for custom finishes
- Available in open reflector, baffle, shower or wall wash trims
- Flush mount adapter available

### Emergency

Remote inverter operates for 90 minutes with remote test switch available, requires above ceiling access.

### Listing / Warranty

- Five (5) year limited warranty
- UL listed to US and Canadian standards for damp locations (Wet location when used with shower trim)



### LPD 17W Housing Order Matrix (Example: EDL5-NC-30-2-LPD)

CCT / CRI	Rev	Wattage / Driver
<b>EDL5-NC-27</b> (2700K / 90 CRI) <b>EDL5-NC-30</b> (3000K / 90 CRI)	-2	-LPD (17W / ERP, Universal Dim, Triac/ELV 10% 120-277V)

### Standard 30W Housing Order Matrix (Example: EDL5-NC-30-2-LR1)

CCT / CRI	Rev	Wattage / Driver
<b>EDL5-NC-27</b> (2700K / 90 CRI) <b>EDL5-NC-30</b> (3000K / 90 CRI) <b>EDL5-NC-35</b> (3500K / 90 CRI)	-2	(blank) (30W / ERP, Universal Dim, Triac/ELV/0-10V 10% 120-277V) -LR1 (30W / Remote Lutron Hi-lume® 2-Wire 1% 120V)

### Electrical Data

Wattage	CCT / CRI	Delivered Lumens	Efficacy
17W	2700K / 90 CRI	1450lm	85lpw
17W	3000K / 90 CRI	1550lm	91lpw
30W	2700K / 90 CRI	2200lm	73lpw
30W	3000K / 90 CRI	2350lm	78lpw
30W	3500K / 90 CRI	2500lm	83lpw

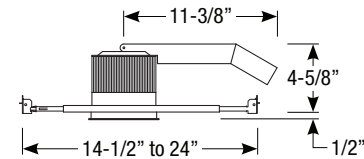
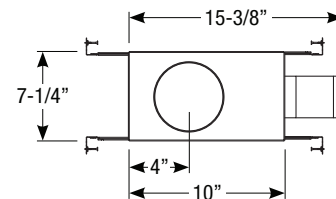
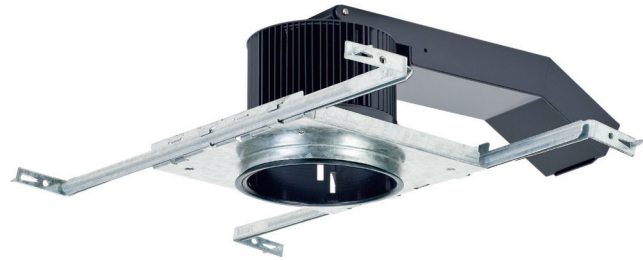

Field Cuttable  
Ceiling Cut-out: 5-1/8" Ø

### Housing Accessories

<b>EDL5-AT-GSKT</b>	Air-Tight IC Gasket for LPD housing
<b>EDL5-MHLDR-1</b>	Media Holder - required for lenses
<b>EDL5-FT-1</b>	Frosted Lens
<b>EDL5-MP-1</b>	Solite Lens
<b>EDL5-CL-1</b>	Clear Lens
<b>EDL5-LN-1</b>	Linear Spread Lens

### Trim Accessories

<b>EDL5-RD-FMA</b>	Round Flush Mount Adapter
<b>EDL5-SQ-FMA</b>	Square Flush Mount Adapter

### Optics

<b>EDL5-10-OPTIC-2</b>	(10° Spot)
<b>EDL5-30-OPTIC-1</b>	(30° Narrow Flood)
<b>EDL5-50-OPTIC-1</b>	(50° Flood)
<b>EDL5-80-OPTIC-1</b>	(80° Wide Flood)

### Emergency

<b>EM-1000</b>	(25W LED Remote Inverter)
<b>EM-1002</b>	(10W LED Remote Emergency Driver)
<b>EM-1003</b>	(35W LED Remote Inverter)
<b>EM-1004</b>	(50W LED Remote Inverter)

# 5" Eco-Downlight Trims

## Open Reflector

EDL5-1000-1  
Clear Alzak Reflector  
White Flange

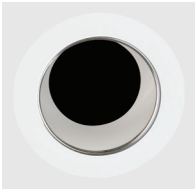

EDL5-1001-1 (Round)  
EDL5-2001-1 (Square)  
Black Reflector  
White Flange

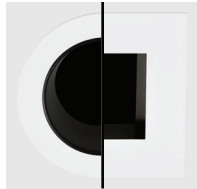

EDL5-1002-1  
Clear Alzak Reflector  
Satin Aluminum Flange

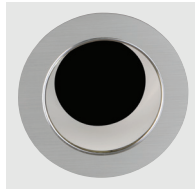

EDL5-1003-1 (Round)  
EDL5-2003-1 (Square)  
Black Reflector  
Satin Aluminum Flange

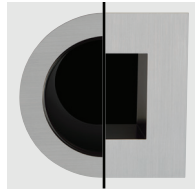

EDL5-1004-1 (Round)  
EDL5-2002-1 (Square)  
Haze Reflector  
White Flange

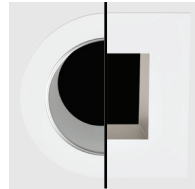

EDL5-1005-1 (Round)  
EDL5-2004-1 (Square)  
Haze Reflector  
Satin Aluminum Flange

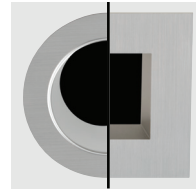

EDL5-1006-1 (Round)  
EDL5-2000-1 (Square)  
White Reflector  
White Flange

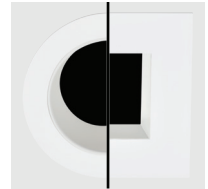

## Baffle Downlight

EDL5-1100-1 (Round)  
EDL5-2100-1 (Square)  
White Baffle  
White Flange

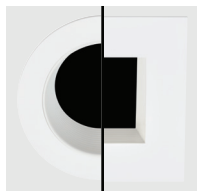

EDL5-1101-1 (Round)  
EDL5-2101-1 (Square)  
Black Baffle  
White Flange

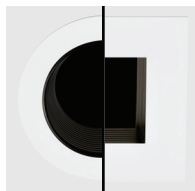

EDL5-1102-1 (Round)  
EDL5-2102-1 (Square)  
Black Baffle  
Satin Aluminum Flange

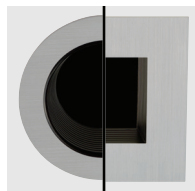

## Shower Trim

EDL5-1200-1  
White Flange



EDL5-1201-1  
Satin Aluminum Flange



EDL5-2200-1  
White Flange



EDL5-2201-1  
Satin Aluminum Flange



## Wall Wash Trim

EDL5-1700-1 (Round)  
EDL5-2300-1 (Square)  
Single Wall Wash  
White Flange



EDL5-1701-1 (Round)  
EDL5-2301-1 (Square)  
Single Wall Wash  
Satin Aluminum Flange

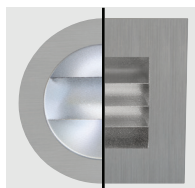

EDL5-1702-1  
Single Wall Wash  
Bronze Flange

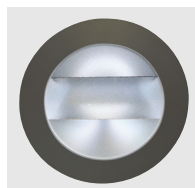

EDL5-1800-1 (Round)  
EDL5-2400-1 (Square)  
Double Wall Wash  
White Flange

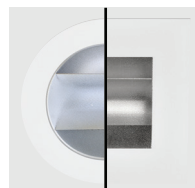

EDL5-1801-1 (Round)  
EDL5-2401-1 (Square)  
Double Wall Wash  
Satin Aluminum Flange

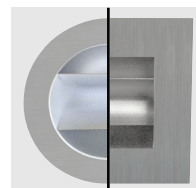

EDL5-1802-1  
Double Wall Wash  
Bronze Flange

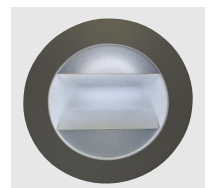

# 5" Eco-Downlight Non-IC Remodel Housing

### Description

Downlight housing delivers up to 2500lm through a 5" aperture with four optical distributions. Remodel housing is rated for non insulated ceilings.

### Field Replaceable LED Light Engine

- 17W LED with 2700K or 3000K @ 90 CRI with 2 SDCM binning
- 30W LED with 2700K, 3000K or 3500K @ 90 CRI with 2 SDCM binning

### Field Replaceable Dimming Driver

- 17W Low power density (LPD) housings include an universal ELV / Triac driver with 120-277V input
- 30W housings are available with remote Lutron Hi-lume® or universal 0-10V / ELV / Triac driver

### Optics

50° flood optic included (10°, 30° and 80° optic are available, must specify)

### Mounting

- Tension clips allow housing to adjust vertically for ceiling thicknesses from 1/2" to 1-1/2"
- Requires a minimum ceiling depth of 7"

### Gasket for IC Installations

17W Low power density (LPD) housings are available with IC Air-Tight gasket, must specify EDL5-AT-GSKT.

### Trims

- Available in round or square aluminum trims, consult factory for custom finishes
- Available in open reflector, baffle, shower or wall wash trims
- Flush mount adapter available

### Emergency

Remote inverter operates for 90 minutes with remote test switch available, requires above ceiling access.

### Listing / Warranty

- Five (5) year limited warranty
- UL listed to US and Canadian standards for damp locations (Wet location when used with shower trim)



### LPD 17W Housing Order Matrix (Example: EDL5-RM-30-2-LPD)

CCT / CRI	Rev	Wattage / Driver
<b>EDL5-RM-27</b> (2700K / 90 CRI) <b>EDL5-RM-30</b> (3000K / 90 CRI)	-2	-LPD (17W / ERP, Universal Dim, Triac/ELV 10% 120-277V)

### Standard 30W Housing Order Matrix (Example: EDL5-RM-30-2-LR1)

CCT / CRI	Rev	Wattage / Driver
<b>EDL5-RM-27</b> (2700K / 90 CRI) <b>EDL5-RM-30</b> (3000K / 90 CRI) <b>EDL5-RM-35</b> (3500K / 90 CRI)	-2	(blank) (30W / ERP, Universal Dim, Triac/ELV/0-10V 10% 120-277V) -LR1 (30W / Remote Lutron Hi-lume® 2-Wire 1% 120V)

### Electrical Data

Wattage	CCT / CRI	Delivered Lumens	Efficacy
17W	2700K / 90 CRI	1450lm	85lpw
17W	3000K / 90 CRI	1550lm	91lpw
30W	2700K / 90 CRI	2200lm	73lpw
30W	3000K / 90 CRI	2350lm	78lpw
30W	3500K / 90 CRI	2500lm	83lpw

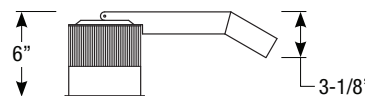
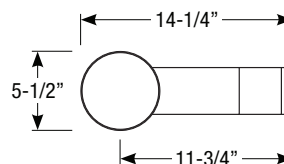

Ceiling Cut-out: 2-1/4" Ø

### Housing Accessories

<b>EDL5-AT-GSKT</b>	Air-Tight IC Gasket for LPD housing
<b>EDL5-MHLDR-1</b>	Media Holder - required for lenses
<b>EDL5-FT-1</b>	Frosted Lens
<b>EDL5-MP-1</b>	Solite Lens
<b>EDL5-CL-1</b>	Clear Lens
<b>EDL5-LN-1</b>	Linear Spread Lens

### Trim Accessories

<b>EDL5-RD-FMA</b>	Round Flush Mount Adapter
<b>EDL5-SQ-FMA</b>	Square Flush Mount Adapter

### Optics

<b>EDL5-10-OPTIC-2</b>	(10° Spot)
<b>EDL5-30-OPTIC-1</b>	(30° Narrow Flood)
<b>EDL5-50-OPTIC-1</b>	(50° Flood)
<b>EDL5-80-OPTIC-1</b>	(80° Wide Flood)

### Emergency

<b>EM-1000</b>	(25W LED Remote Inverter)
<b>EM-1002</b>	(10W LED Remote Emergency Driver)
<b>EM-1003</b>	(35W LED Remote Inverter)
<b>EM-1004</b>	(50W LED Remote Inverter)

# 5" Eco-Downlight Trims

## Open Reflector

EDL5-1000-1  
Clear Alzak Reflector  
White Flange



EDL5-1001-1 (Round)  
EDL5-2001-1 (Square)  
Black Reflector  
White Flange

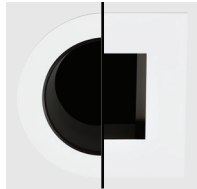

EDL5-1002-1  
Clear Alzak Reflector  
Satin Aluminum Flange

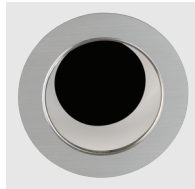

EDL5-1003-1 (Round)  
EDL5-2003-1 (Square)  
Black Reflector  
Satin Aluminum Flange

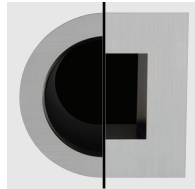

EDL5-1004-1 (Round)  
EDL5-2002-1 (Square)  
Haze Reflector  
White Flange

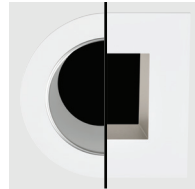

EDL5-1005-1 (Round)  
EDL5-2004-1 (Square)  
Haze Reflector  
Satin Aluminum Flange

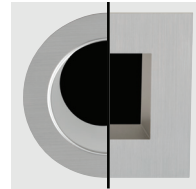

EDL5-1006-1 (Round)  
EDL5-2000-1 (Square)  
White Reflector  
White Flange

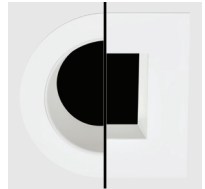

## Baffle Downlight

EDL5-1100-1 (Round)  
EDL5-2100-1 (Square)  
White Baffle  
White Flange

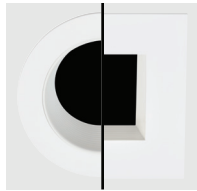

EDL5-1101-1 (Round)  
EDL5-2101-1 (Square)  
Black Baffle  
White Flange

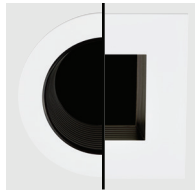

EDL5-1102-1 (Round)  
EDL5-2102-1 (Square)  
Black Baffle  
Satin Aluminum Flange

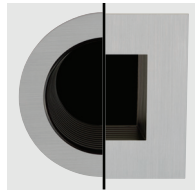

## Shower Trim

EDL5-1200-1  
White Flange



EDL5-1201-1  
Satin Aluminum Flange



EDL5-2200-1  
White Flange



EDL5-2201-1  
Satin Aluminum Flange



## Wall Wash Trim

EDL5-1700-1 (Round)  
EDL5-2300-1 (Square)  
Single Wall Wash  
White Flange



EDL5-1701-1 (Round)  
EDL5-2301-1 (Square)  
Single Wall Wash  
Satin Aluminum Flange

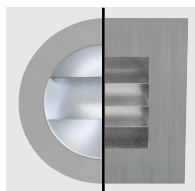

EDL5-1702-1  
Single Wall Wash  
Bronze Flange

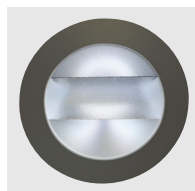

EDL5-1800-1 (Round)  
EDL5-2400-1 (Square)  
Double Wall Wash  
White Flange



EDL5-1801-1 (Round)  
EDL5-2401-1 (Square)  
Double Wall Wash  
Satin Aluminum Flange

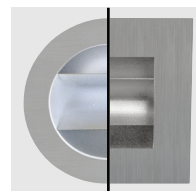

EDL5-1802-1  
Double Wall Wash  
Bronze Flange









# Index

Catalog Number	Page Number	Catalog Number	Page Number	Catalog Number	Page Number
EDL5-10-OPTIC-2	26, 30, 34, 36	EDL5-2100-1	29, 32, 35, 37	EDL5-RM-27-2-LPD	36
EDL5-30-OPTIC-1	26, 30, 34, 36	EDL5-2101-1	29, 32, 35, 37	EDL5-RM-30-2	36
EDL5-50-OPTIC-1	26, 30, 34, 36	EDL5-2102-1	29, 32, 35, 37	EDL5-RM-30-2-LPD	36
EDL5-80-OPTIC-1	26, 30, 34, 36	EDL5-2200-1	28, 33, 35, 37	EDL5-RM-35-2	36
EDL5-1000-1	28, 31, 35, 37	EDL5-2201-1	28, 33, 35, 37	EDL5-SQ-FMA	26, 30, 34, 36
EDL5-1001-1	28, 31, 35, 37	EDL5-2300-1	29, 33, 35, 37	EDL-10-OPTIC-5	10, 14, 18, 22, 24
EDL5-1002-1	28, 31, 35, 37	EDL5-2301-1	29, 33, 35, 37	EDL-30-OPTIC-4	10, 14, 18, 22, 24
EDL5-1003-1	28, 31, 35, 37	EDL5-2400-1	29, 33, 35, 37	EDL-50-OPTIC-4	10, 14, 18, 22, 24
EDL5-1004-1	28, 31, 35, 37	EDL5-2401-1	29, 33, 35, 37	EDL-80-OPTIC-4	10, 14, 18, 22, 24
EDL5-1005-1	28, 31, 35, 37	EDL5-5000-1	28, 31	EDL-1000-4	11, 15, 20, 23, 25
EDL5-1006-1	28, 31, 35, 37	EDL5-5001-1	28, 31	EDL-1001-4	11, 15, 20, 23, 25
EDL5-1100-1	29, 32, 35, 37	EDL5-5002-1	28, 31	EDL-1002-4	11, 15, 20, 23, 25
EDL5-1101-1	29, 32, 35, 37	EDL5-5003-1	28, 31	EDL-1003-4	11, 15, 20, 23, 25
EDL5-1102-1	29, 32, 35, 37	EDL5-5100-1	29, 32	EDL-1004-4	11, 15, 20, 23, 25
EDL5-1200-1	28, 33, 35, 37	EDL5-5101-1	29, 32	EDL-1005-4	11, 15, 20, 23, 25
EDL5-1201-1	28, 33, 35, 37	EDL5-5102-1	29, 32	EDL-1006-4	11, 15, 20, 23, 25
EDL5-1300-1	31	EDL5-5103-1	29, 32	EDL-1007-4	11, 15, 20, 23, 25
EDL5-1301-1	31	EDL5-7000-1	31	EDL-1100-4	12, 16, 20, 23, 25
EDL5-1302-1	31	EDL5-7001-1	31	EDL-1101-4	12, 16, 20, 23, 25
EDL5-1303-1	31	EDL5-7002-1	31	EDL-1102-4	12, 16, 20, 23, 25
EDL5-1304-1	31	EDL5-7003-1	31	EDL-1103-4	12, 16, 20, 23, 25
EDL5-1305-1	31	EDL5-7100-1	32	EDL-1200-4	13, 17, 21, 23, 25
EDL5-1306-1	31	EDL5-7101-1	32	EDL-1201-4	13, 17, 21, 23, 25
EDL5-1307-1	31	EDL5-7102-1	32	EDL-1300-4	11, 15
EDL5-1400-1	32	EDL5-7103-1	32	EDL-1301-4	11, 15
EDL5-1401-1	32	EDL5-ADJ-27-2	26	EDL-1302-4	11, 15
EDL5-1402-1	32	EDL5-ADJ-27-2-LPD	26	EDL-1303-4	11, 15
EDL5-1403-1	32	EDL5-ADJ-30-2	26	EDL-1304-4	11, 15
EDL5-1500-1	31	EDL5-ADJ-30-2-LPD	26	EDL-1305-4	11, 15
EDL5-1501-1	31	EDL5-ADJ-35-2	26	EDL-1306-4	11, 15
EDL5-1502-1	31	EDL5-AT-GSKT	34, 36	EDL-1307-4	11, 15
EDL5-1503-1	31	EDL5-CL-1	26, 30, 34, 36	EDL-1400-4	12, 16
EDL5-1504-1	31	EDL5-FT-1	26, 30, 34, 36	EDL-1401-4	12, 16
EDL5-1505-1	31	EDL5-LN-1	26, 30, 34, 36	EDL-1402-4	12, 16
EDL5-1600-1	32	EDL5-MHLDR-1	26, 30, 34, 36	EDL-1403-4	12, 16
EDL5-1601-1	32	EDL5-MP-1	26, 30, 34, 36	EDL-1500-4	11, 15
EDL5-1602-1	32	EDL5-NC-27-2	34	EDL-1501-4	11, 15
EDL5-1603-1	32	EDL5-NC-27-2-LPD	34	EDL-1502-4	11, 15
EDL5-1700-1	29, 33, 35, 37	EDL5-NC-30-2	34	EDL-1503-4	11, 15
EDL5-1701-1	29, 33, 35, 37	EDL5-NC-30-2-LPD	34	EDL-1504-4	11, 15
EDL5-1702-1	29, 33, 35, 37	EDL5-NC-35-2	34	EDL-1505-4	11, 15
EDL5-1800-1	29, 33, 35, 37	EDL5-NCADJ-27-2	30	EDL-1600-4	12, 16
EDL5-1801-1	29, 33, 35, 37	EDL5-NCADJ-27-2-LPD	30	EDL-1601-4	12, 16
EDL5-1802-1	29, 33, 35, 37	EDL5-NCADJ-30-2	30	EDL-1602-4	12, 16
EDL5-2000-1	28, 31, 35, 37	EDL5-NCADJ-30-2-LPD	30	EDL-1603-4	12, 16
EDL5-2001-1	28, 31, 35, 37	EDL5-NCADJ-35-2	30	EDL-1700-4	13, 17, 21, 23, 25
EDL5-2002-1	28, 31, 35, 37	EDL5-RD-FMA	26, 30, 34, 36	EDL-1701-4	13, 17, 21, 23, 25
EDL5-2003-1	28, 31, 35, 37	EDL5-RD-TR-1	26, 28, 29, 30, 31, 32	EDL-1702-4	13, 17, 21, 23, 25
EDL5-2004-1	28, 31, 35, 37	EDL5-RM-27-2	36	EDL-1800-4	13, 17, 21, 23, 25

## Index

Catalog Number	Page Number	Catalog Number	Page Number	Catalog Number	Page Number
EDL-1801-4	13, 17, 21, 23, 25	EDL-FT-4	10, 14, 18, 22, 24	EDLM-1505-3	3, 5
EDL-1802-4	13, 17, 21, 23, 25	EDL-LN-4	10, 14, 18, 22, 24	EDLM-1506-3	3, 5
EDL-2000-4	11, 15, 20, 23, 25	EDL-MHLDR-4	10, 14, 18, 22, 24	EDLM-1600-3	3, 5
EDL-2001-4	11, 15, 20, 23, 25	EDL-MP-4	10, 14, 18, 22, 24	EDLM-1601-3	3, 5
EDL-2002-4	11, 15, 20, 23, 25	EDL-NC-27-5	22	EDLM-1602-3	3, 5
EDL-2003-4	11, 15, 20, 23, 25	EDL-NC-27-5-LPD	22	EDLM-2001-3	3, 5, 7, 9
EDL-2004-4	11, 15, 20, 23, 25	EDL-NC-30-5	22	EDLM-2003-3	3, 5, 7, 9
EDL-2005-4	11, 15, 20, 23, 25	EDL-NC-30-5-LPD	22	EDLM-2004-3	3, 5, 7, 9
EDL-2100-4	12, 16, 20, 23, 25	EDL-NC-35-5	22	EDLM-2005-3	3, 5, 7, 9
EDL-2101-4	12, 16, 20, 23, 25	EDL-NCADJ-27-5	14	EDLM-2006-3	3, 5, 7, 9
EDL-2102-4	12, 16, 20, 23, 25	EDL-NCADJ-27-5-LPD	14	EDLM-2100-3	3, 5, 7, 9
EDL-2103-4	12, 16, 20, 23, 25	EDL-NCADJ-30-5	14	EDLM-2101-3	3, 5, 7, 9
EDL-2200-4	13, 17, 21, 23, 25	EDL-NCADJ-30-5-LPD	14	EDLM-2102-3	3, 5, 7, 9
EDL-2201-4	13, 17, 21, 23, 25	EDL-NCADJ-35-5	14	EDLM-2200-3	3, 5, 7, 9
EDL-2300-4	13, 17, 21, 23, 25	EDL-RD-FMA	10, 14, 18, 22, 24	EDLM-ADJ-27-4	2
EDL-2301-4	13, 17, 21, 23, 25	EDL-RD-TR-4	10, 11, 12, 14, 15, 16, 18, 20	EDLM-ADJ-27-4-LPD	2
EDL-2302-4	13, 17, 21, 23, 25	EDL-RM-27-5	24	EDLM-ADJ-30-4	2
EDL-2400-4	13, 17, 21, 23, 25	EDL-RM-27-5-LPD	24	EDLM-ADJ-30-4-LPD	2
EDL-2401-4	13, 17, 21, 23, 25	EDL-RM-30-5	24	EDLM-ADJ-35-4	2
EDL-2402-4	13, 17, 21, 23, 25	EDL-RM-30-5-LPD	24	EDLM-AT-GSKT	6, 8
EDL-3000-4	13, 17	EDL-RM-35-5	24	EDLM-NC-27-4	6
EDL-3001-4	13, 17	EDL-SIC-27-5	18	EDLM-NC-27-4-LPD	6
EDL-3002-4	13, 17	EDL-SIC-30-5	18	EDLM-NC-30-4	6
EDL-4000-4	13, 17	EDL-SIC-35-5	18	EDLM-NC-30-4-LPD	6
EDL-4001-4	13, 17	EDL-SQ-FMA	10, 14, 18, 22, 24	EDLM-NC-35-4	6
EDL-4002-4	13, 17	EDLM-10-OPTIC-3	2, 4, 6, 8	EDLM-NCADJ-27-4	4
EDL-5000-4	11, 15, 20	EDLM-30-OPTIC-3	2, 4, 6, 8	EDLM-NCADJ-27-4-LPD	4
EDL-5001-4	11, 15, 20	EDLM-50-OPTIC-3	2, 4, 6, 8	EDLM-NCADJ-30-4	4
EDL-5002-4	11, 15, 20	EDLM-80-OPTIC-3	2, 4, 6, 8	EDLM-NCADJ-30-4-LPD	4
EDL-5003-4	11, 15, 20	EDLM-1001-3	3, 5, 7, 9	EDLM-NCADJ-35-4	4
EDL-5100-4	12, 16, 20	EDLM-1003-3	3, 5, 7, 9	EDLM-RD-FMA	4, 6, 8
EDL-5101-4	12, 16, 20	EDLM-1004-3	3, 5, 7, 9	EDLM-RM-27-4	8
EDL-5102-4	12, 16, 20	EDLM-1005-3	3, 5, 7, 9	EDLM-RM-27-4-LPD	8
EDL-5103-4	12, 16, 20	EDLM-1006-3	3, 5, 7, 9	EDLM-RM-30-4	8
EDL-7000-4	11, 15	EDLM-1100-3	3, 5, 7, 9	EDLM-RM-30-4-LPD	8
EDL-7001-4	11, 15	EDLM-1101-3	3, 5, 7, 9	EDLM-RM-35-4	8
EDL-7002-4	11, 15	EDLM-1102-3	3, 5, 7, 9	EDLM-SQ-FMA	4, 6, 8
EDL-7003-4	11, 15	EDLM-1200-3	3, 5, 7, 9	EM-1000	2, 4, 6, 8, 10, 14, 18, 22, 24, 26, 30, 34, 36
EDL-7100-4	12, 16	EDLM-1301-3	3, 5	EM-1002	2, 4, 6, 8, 10, 14, 18, 22, 24, 26, 30, 34, 36
EDL-7101-4	12, 16	EDLM-1303-3	3, 5	EM-1003	2, 4, 6, 8, 10, 14, 18, 22, 24, 26, 30, 34, 36
EDL-7102-4	12, 16	EDLM-1304-3	3, 5	EM-1004	2, 4, 6, 8, 10, 14, 18, 22, 24, 26, 30, 34, 36
EDL-7103-4	12, 16	EDLM-1305-3	3, 5		
EDL-ADJ-27-5	10	EDLM-1306-3	3, 5		
EDL-ADJ-27-5-LPD	10	EDLM-1401-3	3, 5		
EDL-ADJ-30-5	10	EDLM-1402-3	3, 5		
EDL-ADJ-30-5-LPD	10	EDLM-1403-3	3, 5		
EDL-ADJ-35-5	10	EDLM-1501-3	3, 5		
EDL-AT-GSKT	22, 24	EDLM-1503-3	3, 5		
EDL-CL-4	10, 14, 18, 22, 24	EDLM-1504-3	3, 5		



A Division of Troy-CSL Lighting, Inc.

14508 Nelson Avenue  
City of Industry, CA 91744  
Tel: 626.336.4511  
Fax: 626.330.4266

[www.csllighting.com](http://www.csllighting.com)



Copyright © 2018 Troy-CSL Lighting, Inc.