

⚠ WARNING
DISCONNECT POWER BEFORE RE-LAMPING OR WIRING THE FIXTURE
READ ALL INSTRUCTIONS COMPLETELY BEFORE STARTING INSTALLATION.

⚠ CAUTION

- TO AVOID THE RISK OF FIRE OR SHOCK, FIXTURE MUST BE INSTALLED IN COMPLIANCE WITH ALL APPLICABLE NATIONAL AND LOCAL ELECTRICAL/BUILDING CODES.
- INSTALLATION AND MAINTENANCE OF THIS UNIT REQUIRES AN ELECTRICIAN OR CERTIFIED FACTORY TRAINED TECHNICIAN.
- If an existing fixture is being replaced, remove it and note to which of the wires in the junction box the fixture was attached. DO NOT SEPARATE ANY OTHER WIRES THAT MAY BE IN THE BOX. DO NOT DAMAGE THE INSULATION OF OLDER WIRING. In regular circumstances the BLACK wire will be the "Hot" lead and the WHITE wire will be the "Neutral" or "Common" lead A GREEN or BARE COPPER wire is the "Ground". In older buildings it is always good practice to reconfirm the polarity of the wiring.

NOTICE

- The important safeguards and instructions outlined on this sheet cannot cover all possible conditions and situations that may occur. it must be understood that common sense, caution and care factors that cannot be built into any product. Caution and care must be supplied by the person(s) installing, operating and caring of this lighting fixture.
- This fixture is designed to be mounted on a correctly installed standard round or octagon box or a through wiring box with a plaster frame. The box must be securely mounted to the structure of the building. The heavy duty strap and hardware supplied should be used. directly mounting the fixture to the junction box may make it impossible to correctly align the fixture.

NOTICE:
CALIFORNIA PROP 65: THIS LIGHTING FIXTURE CONTAINS CHEMICALS KNOWN TO THE STATE OF CALIFORNIA TO CAUSE CANCER, BIRTH DEFECTS, AND/OR OTHER REPRODUCTIVE HARM. WASH HANDS AFTER USE.

FIXTURE PREPARATION

1. Remove the fixture, parts and parts bag(s) from the carton.

NOTICE:

- Before discarding the carton, double check to make certain that all parts are found.

FIXTURE INSTALLATION

1. Attach the modified heavy duty strap unto the junction box. Then attach the SAFETY CABLE to the building structure or brace.
 (The green screw should face the floor). (See FIGURE-01.)

⚠ WARNING
REFER TO THE ILLUSTRATION FOR CORRECT AND SAFE INSTALLATION OF SAFETY CABLE. FAILURE TO FOLLOW THIS INSTRUCTION COULD RESULT HARM/DAMAGE TO THE FIXTURE, PROPERTY AND/OR PERSON(S)!

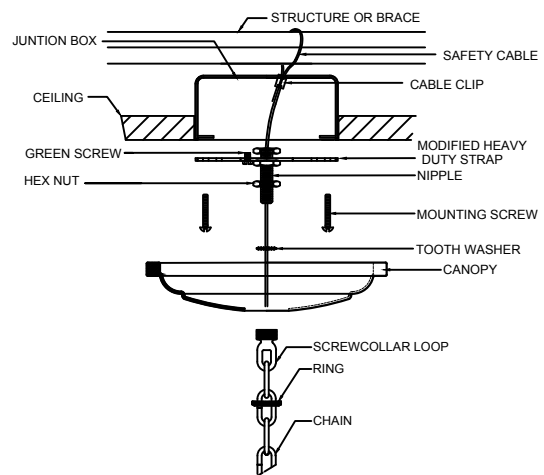

FIGURE-01

2. Remove the threaded ring from the screw collar loop. Fully thread the screw collar loop onto the nipple. Thread the hex nut onto the nipple and the nipple into the heavy duty strap. Place the canopy over the screw collar and against the ceiling. Adjust the nipple so that 1/4" of threads on the screw collar loop extend beyond the canopy. Tighten the hex nut against the modified heavy duty strap. Using the threaded ring, install the canopy. (See Figure 1.)

3. Hang the fixture on the chain at the desired height. Remove excess chain and close all links, then attach the chain link to the collar loop. Unscrew the threaded ring from the collar loop. Allow the ring and canopy to slide down the chain to the top of the fixture.

⚠ WARNING
The use of chain pliers for opening and closing chain is required. The use of tools other than the chain pliers may damage the chain link resulting in a failure which causes harm to the fixture, property and/or person!

4. Measure 6" of lead and ground wire beyond the top of the chain. Cut off excess wire. Strip the insulation off the ends of the leads exposing approx. 1/2" of wire. Twist the strands of wire together. Push the leads and ground wire up through the screwcollar loop and into the junction box.

5. Fasten the ground wire to the green or bare copper wire in the junction box of the green screw or the modified heavy duty strap.

⚠ WARNING
Never fasten the ground wire to the white or hot wire! Failure to follow instruction could result in serious injury or death!

6. Fasten the fixture's lead hot wire to hot wire in the junction box. Fasten the wires together with an approved fastener(wire nut). Starting about 1" below the fastener, tightly wrap the connection with electrical tape so that the connections seals the end of the fastener. NOTE: SPT Hot Wire is the one with the writings.

⚠ WARNING
Make sure that there is no exposed wire or strands that could cause a dangerous short circuit!

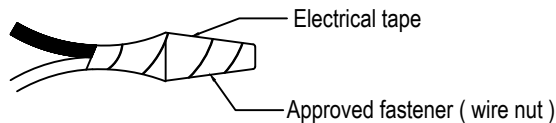

7. Connect the fixture lead's neutral wire to the neutral wire in the junction box. Fasten the joined wires as in step 6. NOTE: SPT Cord's Neutral wire does not have any writings on it.

8. Slide the canopy up the chain and fasten using the threaded ring to the ceiling. (See Figure 02)

9. Place the lamp into the socket of the fixture.

NOTICE:
 This fixture is rated for 60w Type-B.

⚠ WARNING
DO NOT EXCEED RECOMMENDED WATTAGE!

10. Restore power to the circuit breaker or fuse box.

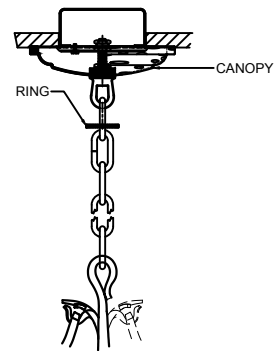
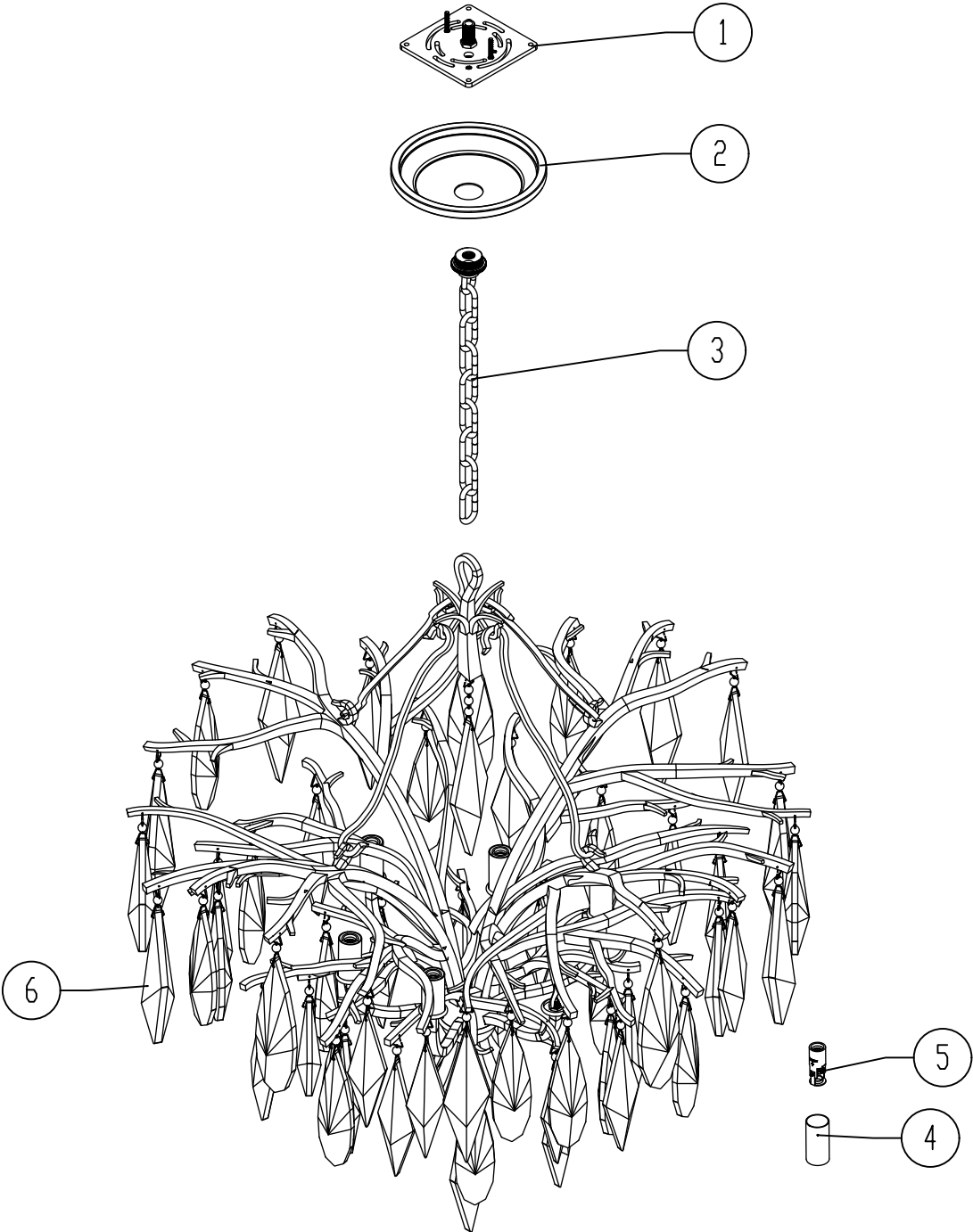

FIGURE-02









R-MT37
306-06

ITEM NUMBER	PART NUMBER	DESCRIPTION
1	R-MT37-HRD	MOUNTING KIT
2	R-MT37-CPY	CANOPY
3	R-MT37-DCH	CHAIN
4	R-MT37-CAC	SOCKET COVER
5	R-MT37-ESK	SOCKET
6	R-MT37-GLS	GLASS

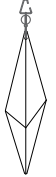

NERA 6-LT PENDANT

306-06 CRYSTAL SCHEDULES

LEGEND:				
5 PCS.  LSA LARGE SMOKE ALMOND	15 PCS.  MSA MEDIUM SMOKE ALMOND	5 PCS.  MBA MEDIUM BLACK ALMOND	13 PCS.  MBD MEDIUM BLACK DIAMOND	3 PCS.  SBD SMALL BLACK DIAMOND
5 PCS.  LSD LARGE SMOKE DIAMOND	5 PCS.  MSD MEDIUM SMOKE DIAMOND	2 PCS.  LBD LARGE BLACK DIAMOND		

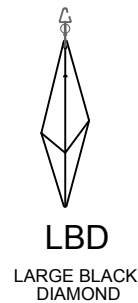

1. USE A LARGE BLACK DIAMOND CRYSTAL ON THE TOP HANGER WITH THREE PIECES BEADS.

TOP FINIAL

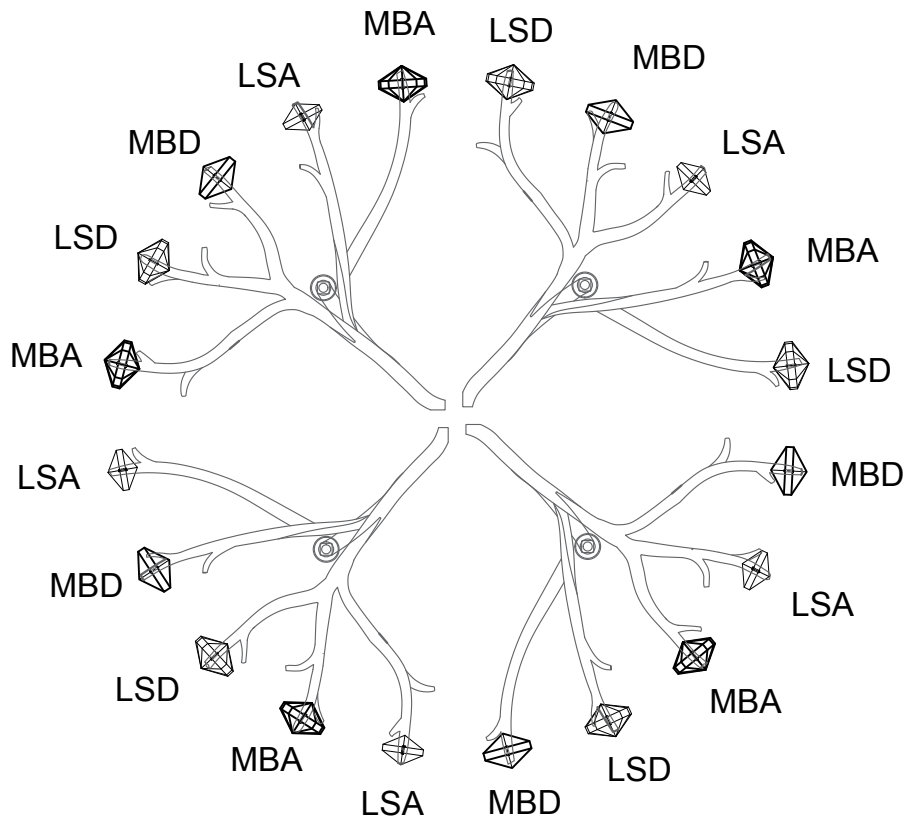

FIRST LAYER

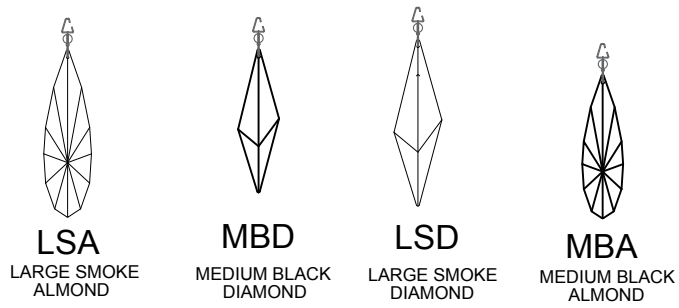

2. FOLLOW THIS SEQUENCE ON THE FIRST LAYER AND REPEAT IT 5 TIMES.

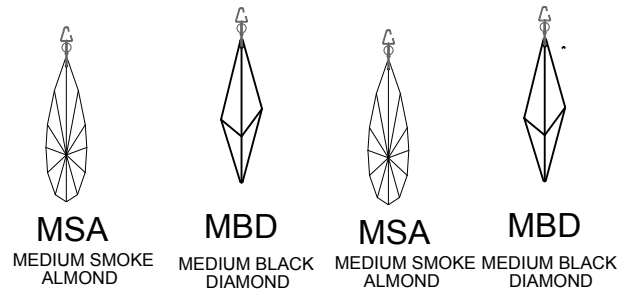
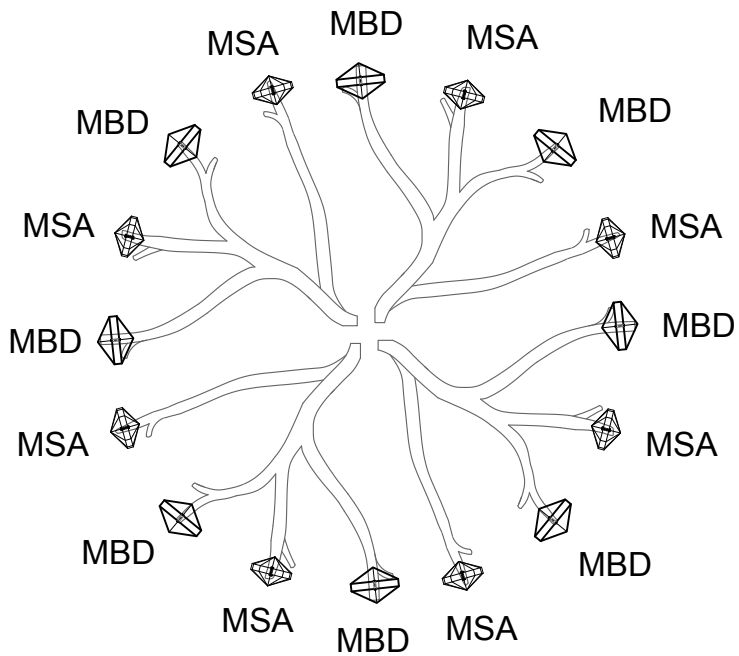

3. FOLLOW THIS SEQUENCE ON THE SECOND LAYER AND REPEAT IT 4 TIMES.

SECOND LAYER

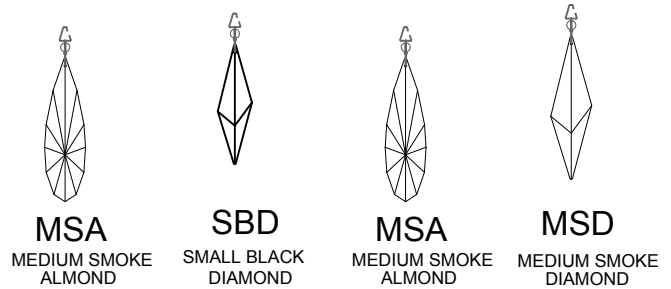
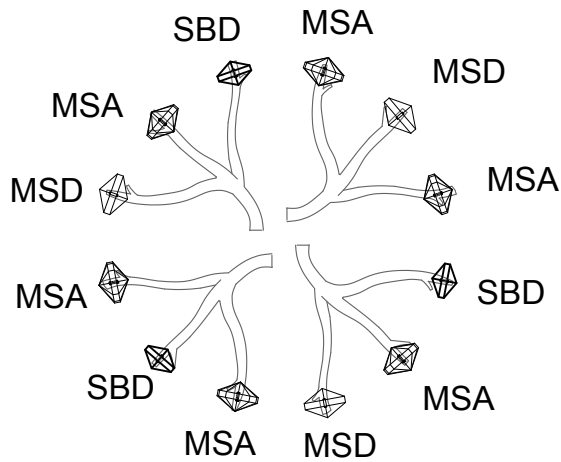

4. FOLLOW THIS SEQUENCE ON THE THIRD LAYER AND REPEAT IT 3 TIMES.

THIRD LAYER

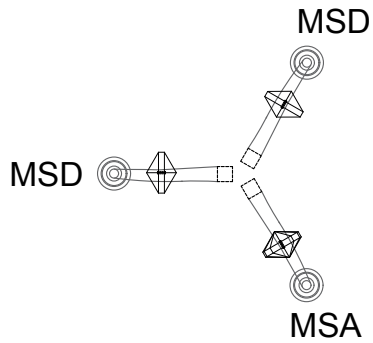

FOURTH LAYER



LBD

BOTTOM FINIAL

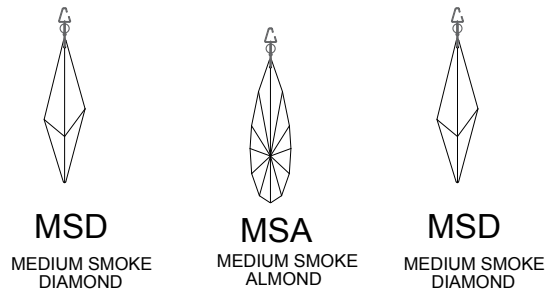

5. FOLLOW THIS SEQUENCE ON THE FOURTH LAYER WHERE THE LOWER LAMPS ARE LOCATED.

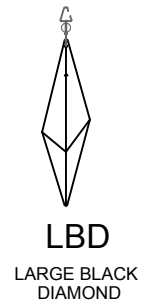

6. USE A LARGE BLACK DIAMOND CRYSTAL ON THE BOTTOM WITH THREE PIECES BEADS.