

WARNING

**DISCONNECT POWER BEFORE RE-LAMPING OR WIRING THE FIXTURE
READ ALL INSTRUCTIONS COMPLETELY BEFORE STARTING INSTALLATION.**

CAUTION

- TO AVOID THE RISK OF FIRE OR SHOCK, FIXTURE MUST BE INSTALLED IN COMPLIANCE WITH ALL APPLICABLE NATIONAL AND LOCAL ELECTRICAL/BUILDING CODES.
- INSTALLATION AND MAINTENANCE OF THIS UNIT REQUIRES AN ELECTRICIAN OR CERTIFIED FACTORY TRAINED TECHNICIAN.
- If an existing fixture is being replaced, remove it and note to which of the wires in the outlet box the fixture was attached. DO NOT SEPARATE ANY OTHER WIRES THAT MAY BE IN THE BOX. DO NOT DAMAGE THE INSULATION OF OLDER WIRING. In regular circumstances the BLACK wire will be the "Hot" lead and the WHITE wire will be the "Neutral" or "Common" lead. A GREEN or BARE COPPER wire is the "Ground". In older buildings it is always good practice to reconfirm the polarity of the wiring.

NOTICE

- The important safeguards and instructions outlined on this sheet cannot cover all possible conditions and situations that may occur. It must be understood that common sense, caution and care factors that cannot be built into any product. Caution and care must be supplied by the person(s) installing, operating and caring of this lighting fixture.
- This fixture is designed to be mounted on a correctly installed standard round or octagon box or a through wiring box with a plaster frame. The box must be securely mounted to the structure of the building. The crossbar and hardware supplied should be used. Directly mounting the fixture to the outlet box may make it impossible to correctly align the fixture.

NOTICE:

CALIFORNIA PROP 65: THIS LIGHTING FIXTURE CONTAINS CHEMICALS KNOWN TO THE STATE OF CALIFORNIA TO CAUSE CANCER, BIRTH DEFECTS, AND/OR OTHER REPRODUCTIVE HARM. WASH HANDS AFTER USE.

FIXTURE PREPARATION

1. Remove the fixture, parts and parts bag(s) from the carton.

NOTICE:

- Before discarding the carton, double check to make certain that all parts are found.

FIXTURE INSTALLATION

1. Attach the mounting strap to the junction box. (The green screw should face the floor)
Place the mounting strap at the junction box and fasten using the round head screw.
2. Remove the threaded ring from the screw collar loop. Fully thread the screw collar loop onto the nipple. Thread the hex nut onto the nipple and the nipple into the mounting strap. Place the canopy over the screw collar and against the ceiling. Adjust the nipple so that $\frac{1}{4}$ " of threads on the screw collar loop extend beyond the canopy. Tighten the hex nut against the crossbar. Using the threaded ring, install the canopy. (See Figure -01)

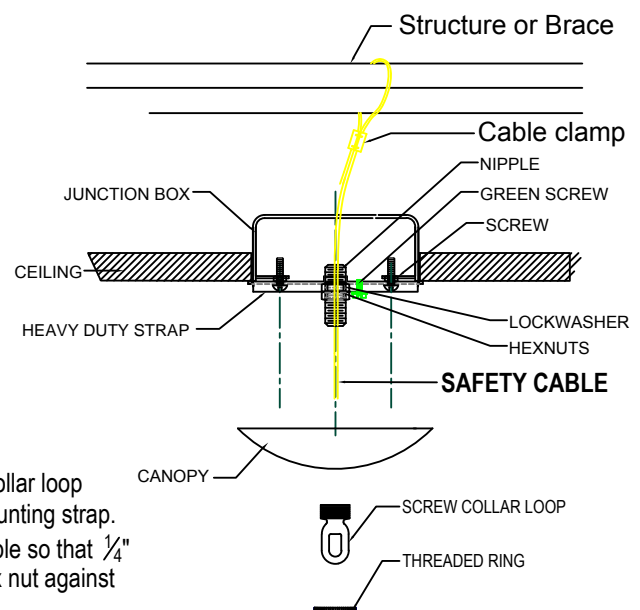
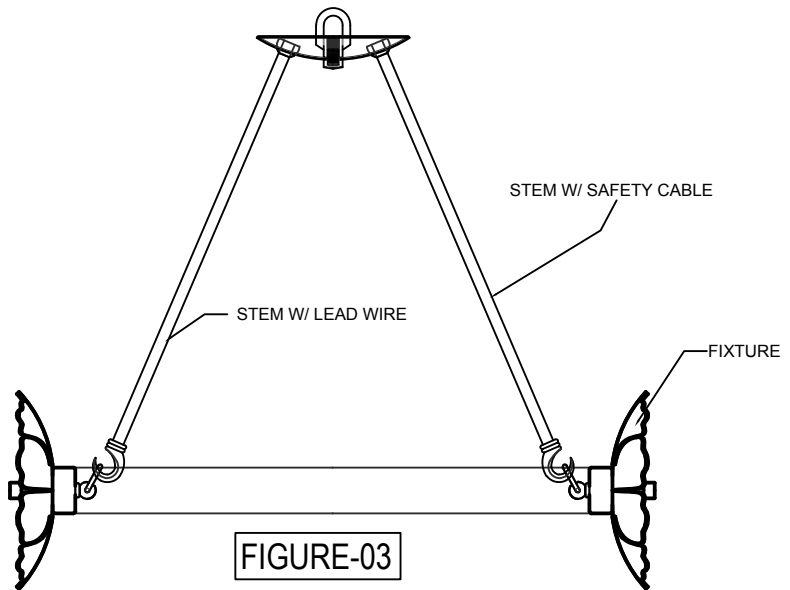
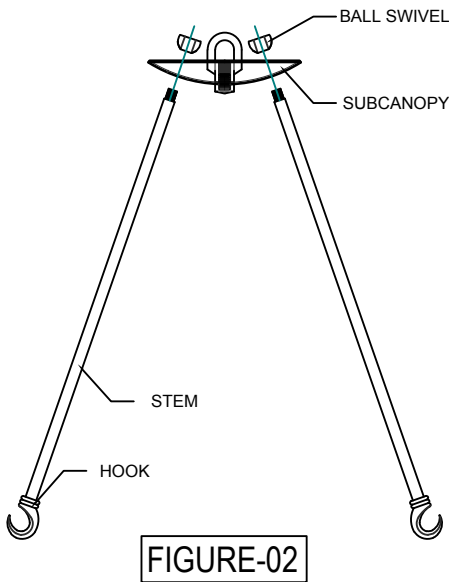

FIGURE-01

3. Assemble the stems with hook to the sub-canopy, fasten to the ball swivel. (See Figure-02)
4. Hang the fixture to the hooks. (See Figure-03)



5. Open the end links of the chain and attach the chain to the screw collar loop. Insert the lead wire to the stem then thread in the stem into the frame. Hang the fixture on the chain at the desired height. Remove the excess chain close all links. Unscrew the threaded ring from the screw collar loop. Allow the ring and canopy to slide down the chain to the top of the fixture.

⚠ WARNING
 The use of chain pliers for opening and closing chain is required. The use of tools other than the chain pliers may damage the chain link resulting in a failure which can cause harm to the fixture, property and/or person(s)!!!

6. Attach the Safety cable to the building or structure or brace.
7. Measure 6" of lead and ground wire beyond the top of the chain. Cut off the excess wire. Strip the insulation off the ends of the leads exposing approx. 1/2" of wire. Twist the strands of wire together. Push the leads and ground wire up through the screwcollar loop and into the outlet box.
8. Fasten the ground wire to the green or bare copper wire in the outlet box of the green screw on the mounting strap.

⚠ WARNING
 Never fasten the ground wire to the black or "hot" wire!
 Failure to follow this instruction could result in serious injury or death!

9. Fasten the white fixture lead to the white wire in the outlet box. Fasten the wires together with an approved fastener (wire nut). Starting about 1" below the fastener, tightly wrap the connection with electrical tape so that the connections seals the end of the fastener.

⚠ WARNING
 Make sure that there is no exposed wire or strands that could cause a dangerous short circuit!

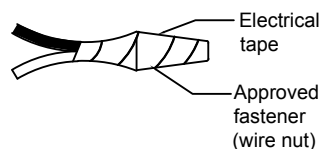

10. Connect the black fixture lead to the black wire in the outlet box. Fasten the joined wires as in step 9.

11. Slide the canopy up the chain and fasten using the threaded ring to the ceiling. (See Figure-05)

12. Install the lamps. (type-G9 lamp)

NOTICE:
This fixture is rated for 20w G9 lamp.

WARNING
DO NOT EXCEED RECOMMENDED WATTAGE!

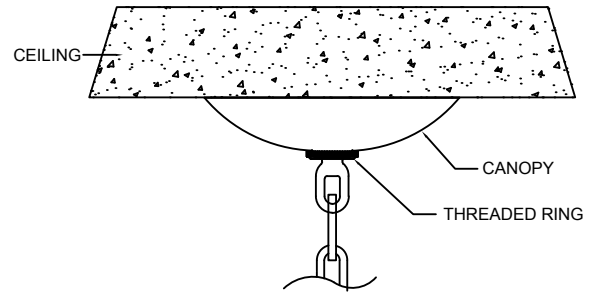

FIGURE-05

13. Install the glass ball diffuser and accent flower. Insert the accent flower to the flower on the frame then secure it with the glass ball with fitter. (See Figure-06).

14. Restore power to the circuit breaker or fuse box.

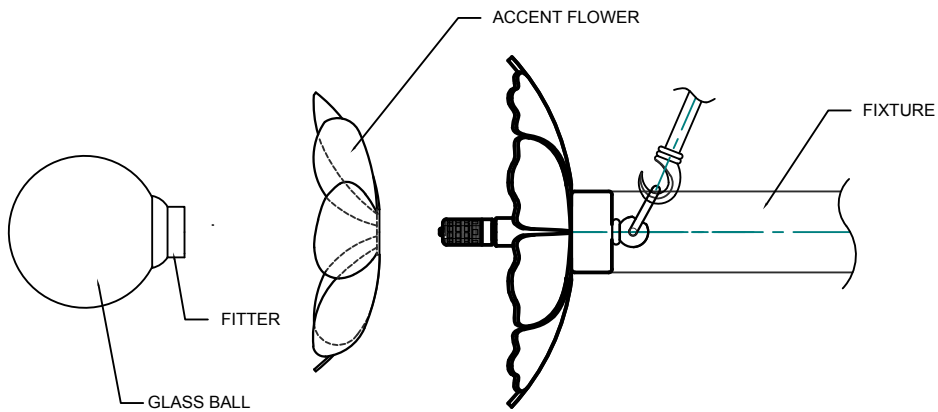
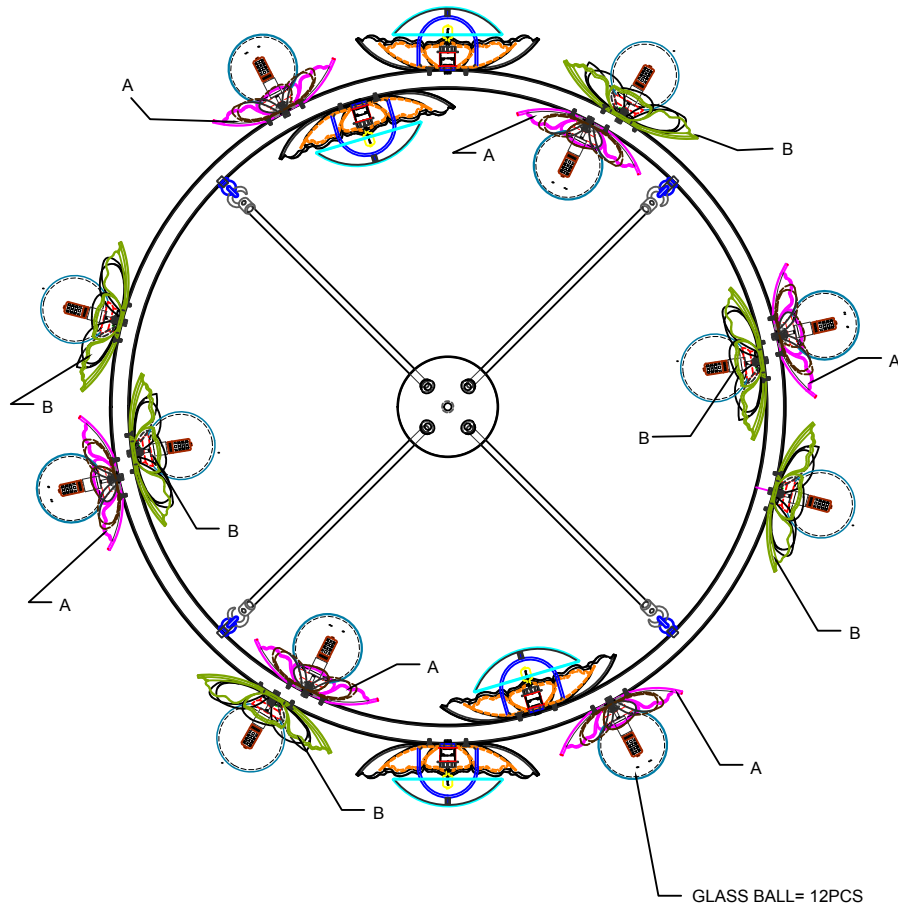

FIGURE-06

GLASS SCHEDULE



LEGEND:

- 1. A = SMALL FLOWER = 6 PCS
- 2. B = MEDIUM FLOWER = 6 PCS

GLASS BALL = 12PCS