

⚠ WARNING
DISCONNECT POWER BEFORE RE-LAMPING OR WIRING THE FIXTURE
READ ALL INSTRUCTIONS COMPLETELY BEFORE STARTING INSTALLATION.

⚠ CAUTION

- TO AVOID THE RISK OF FIRE OR SHOCK, FIXTURE MUST BE INSTALLED IN COMPLIANCE WITH ALL APPLICABLE NATIONAL AND LOCAL ELECTRICAL/BUILDING CODES.
- INSTALLATION AND MAINTENANCE OF THIS UNIT REQUIRES AN ELECTRICIAN OR CERTIFIED FACTORY TRAINED TECHNICIAN.
- If an existing fixture is being replaced, remove it and note to which of the wires in the outlet box the fixture was attached. DO NOT SEPARATE ANY OTHER WIRES THAT MAY BE IN THE BOX. DO NOT DAMAGE THE INSULATION OF OLDER WIRING. In regular circumstances the BLACK wire will be the "Hot" lead and the WHITE wire will be the "Neutral" or "Common" lead. The GREEN or BARE COPPER wire is the "Ground". In older buildings it is always good practice to reconfirm the polarity of the wiring.

NOTICE

- The important safeguards and instructions outlined on this sheet cannot cover all possible conditions and situations that may occur. it must be understood that common sense, caution and care factors that cannot be built into any product. Caution and care must be supplied by the person(s) installing, operating and caring of this lighting fixture.
- This fixture is designed to be mounted on a correctly installed standard round or octagon box or a through wiring box with a plaster frame. The box must be securely mounted to the structure of the building. The heavy duty strap and hardware supplied should be used. directly mounting the fixture to the outlet box may make it impossible to correctly align the fixture.)
- This fixture is supplied with with a 4-pcs. stem. There is one 6" section, two 12" section and one 18" section. This feature allows the fixture to be mounted with a stem up to 48" in length in 6" increments (See figure-2)
- This fixture is supplied with a swivel. By rotating the canopy the fixture may be mounted to angled ceiling.

NOTICE:
CALIFORNIA PROP 65: THIS LIGHTING FIXTURE CONTAINS CHEMICALS KNOWN TO THE STATE OF CALIFORNIA TO CAUSE CANCER, BIRTH DEFECTS, AND/OR OTHER REPRODUCTIVE HARM. WASH HANDS AFTER USE.

FIXTURE PREPARATION

1. Remove the fixture, glass, metal prism and parts bag(s) from the carton.

NOTICE:

- Before discarding the carton, double check to make certain that all parts are found.
- Do not remove the tripod until after installation.
- Only handle/lift fixture by tripod or center stem.

FIXTURE INSTALLATION

1. Attach the **SAFETY CABLE** to the building structure or brace (See figure-1).

NOTICE:
 THIS LUMINAIRE MUST USE JUNCTION BOX RATED FOR MINIMUM 90 LBS AND INSTALL PER JUNCTION BOX INSTRUCTION.

⚠ WARNING
REFER TO THE ILLUSTRATION FOR CORRECT AND SAFE INSTALLATION OF SAFETY CABLE. FAILURE TO FOLLOW THIS INSTRUCTION COULD RESULT HARM/DAMAGE TO THE FIXTURE, PROPERTY AND/OR PERSON(S)!

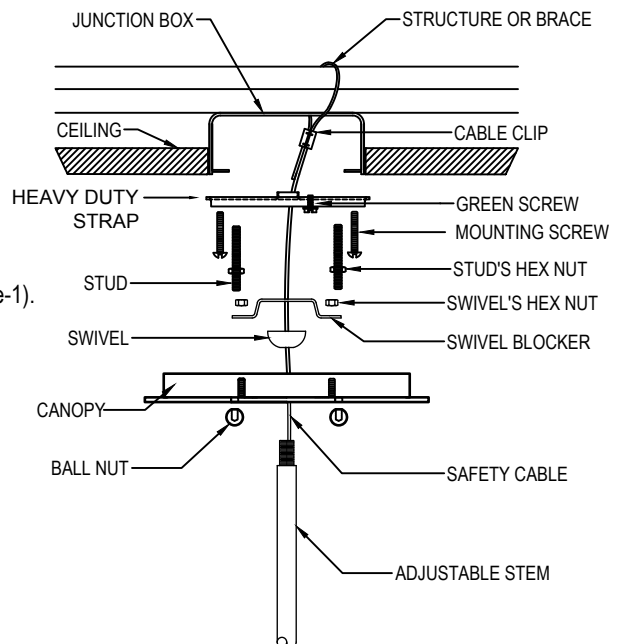



FIGURE-1

2. Determine the overall desired length of the fixture.
Assemble the adjustable stems one at a time onto the fixture leads. Tape the end of the leads to a stiff wire (coat hanger) to aid in pulling them through the stems. Place the canopy onto the stem. Assemble the top stem section, decorative breaker, fixture stem and swivel. Place the swivel blocker over the stud of the canopy and thread the hex nuts onto them.

3. Attach the heavy duty strap to the junction box.
(The green screw should face the floor).
Thread the studs into the heavy duty strap at the spacing that matches the mounting holes in the canopy. Adjust the screw so they extend 3/16" beyond the canopy.

4. Cut off the excess ground and fixture wire 6" beyond the canopy. Strip 1/2" of insulation from the ends of the wire. Twist the wire stands together.

5. Fasten the ground wire to the green or bare copper wire in the junction box or the green screw on the heavy duty strap.

 **WARNING**
Never fasten the ground wire to the black or "hot" wire! Failure to follow this instruction could result in serious injury or death!

6. Fasten the white fixture lead to the white wire in the junction box. Fasten the wires together with an approved fastener (wire nut). Starting about 1" below the fastener, tightly wrap the connection with electrical tape so that the connections seals the end of the fastener.

 **WARNING**
Make sure that there is no exposed wire or strands that could cause a dangerous short circuit!

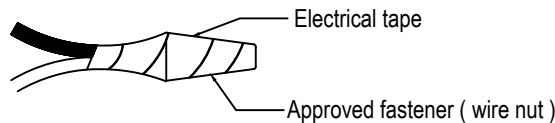

7. Connect the black fixture lead to the black wire in the junction box. Fasten the joined wires as in step 6.

8. Using the ball nuts, loosely fasten the fixture to the heavy duty strap. Rotate and align the canopy as necessary. Tighten the ball nuts.

9. Install the lamps (lighting bulbs). NOTE:
This fixture is rated for 60 watt type B.

 **WARNING**
DO NOT EXCEED RECOMMENDED WATTAGE!

10. Restore power to circuit at breaker or fuse box.

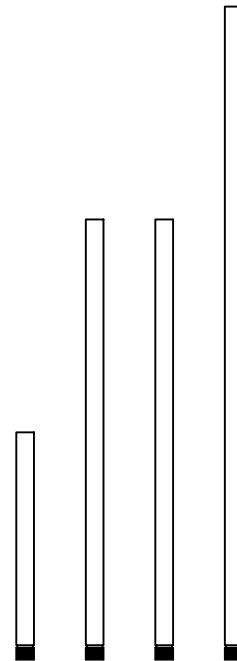

ADJUSTABLE STEM

FIGURE-2

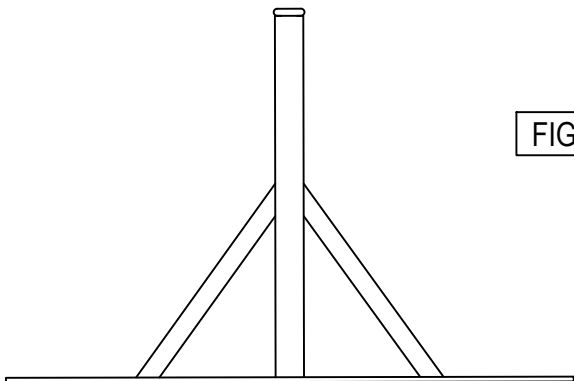
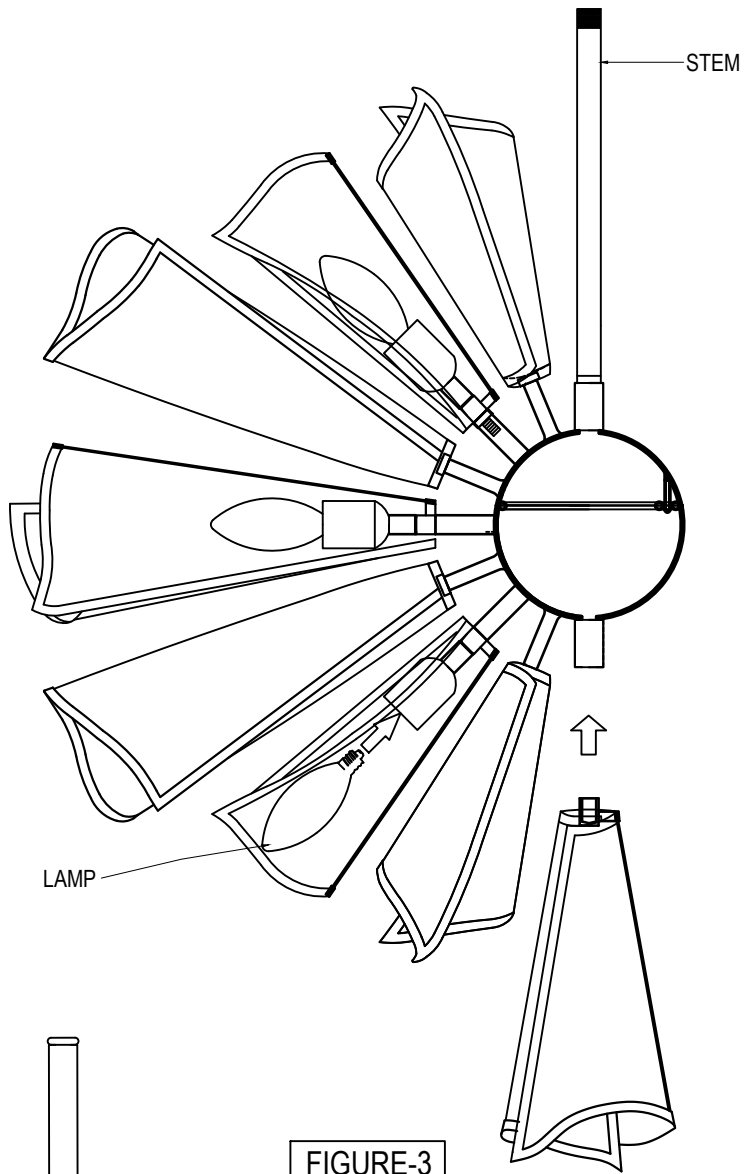

TRIPOD