

⚠ WARNING

**DISCONNECT POWER BEFORE RE-LAMPING OR WIRING THE FIXTURE
READ ALL INSTRUCTIONS COMPLETELY BEFORE STARTING INSTALLATION.**

⚠ CAUTION

- TO AVOID THE RISK OF FIRE OR SHOCK, FIXTURE MUST BE INSTALLED IN COMPLIANCE WITH ALL APPLICABLE NATIONAL AND LOCAL ELECTRICAL/BUILDING CODES.
- INSTALLATION AND MAINTENANCE OF THIS UNIT REQUIRES AN ELECTRICIAN OR CERTIFIED FACTORY TRAINED TECHNICIAN.
- If an existing fixture is being replaced, remove it and note to which of the wires in the junction box the fixture was attached. DO NOT SEPARATE ANY OTHER WIRES THAT MAY BE IN THE BOX. DO NOT DAMAGE THE INSULATION OF OLDER WIRING. In regular circumstances the BLACK wire will be the "Hot" lead and the WHITE wire will be the "Neutral" or "Common" lead A GREEN or BARE COPPER wire is the "Ground". In older buildings it is always good practice to reconfirm the polarity of the wiring.

NOTICE

- The important safeguards and instructions outlined on this sheet cannot cover all possible conditions and situations that may occur. it must be understood that common sense, caution and care factors that cannot be built into any product. Caution and care must be supplied by the person(s) installing, operating and caring of this lighting fixture.
- This fixture is designed to be mounted on a correctly installed standard round or octagon box or a through wiring box with a plaster frame. The box must be securely mounted to the structure of the building. The mounting ring and hardware supplied should be used. directly mounting the fixture to the junction box may make it impossible to correctly align the fixture.

NOTICE:

CALIFORNIA PROP 65: THIS LIGHTING FIXTURE CONTAINS CHEMICALS KNOWN TO THE STATE OF CALIFORNIA TO CAUSE CANCER, BIRTH DEFECTS, AND/OR OTHER REPRODUCTIVE HARM. WASH HANDS AFTER USE.

THIS LUMINAIRE MUST BE MOUNTED OR SUPPORTED INDEPENDENTLY OF AN OUTLET BOX

FIXTURE PREPARATION

1. Remove the fixture, parts and parts bag(s) from the carton.

NOTICE:

- Before discarding the carton, double check to make certain that all parts are found.

FIXTURE INSTALLATION

1. Attach the mounting ring to the junction box using mounting screw. (the green screw should face out). (See Figure 01)
2. Fasten the ground wire to the green or bare copper wire in the junction box of the green screw on the mounting ring.

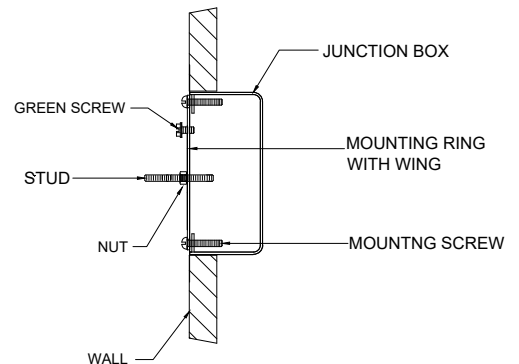

⚠ WARNING

**Never fasten the ground wire to the black or "hot" wire!
Failure to follow this instruction could result in serious injury or death!**

3. Fasten the white fixture lead to the white wire in the junction box. Fasten the wires together with an approved fastener (wire nut). Starting about 1" below the fastener, tightly wrap the connection with electrical tape so that the connections seals the end of the fastener.

FIGURE-01



WARNING

Make sure that there is no exposed wire or strands that could cause a dangerous short circuit!

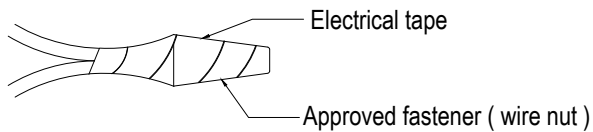

4. Connect the black fixture lead to the black wire in the junction box. Fasten the joined wires as in step 3.
5. Attach the the backplate to the mounting ring and secure it with ball nut (See Figure 02).
6. Place the bulb into the socket of the fixture.

NOTICE:

This fixture is rated for 60w type-B lamp.



WARNING

DO NOT EXCEED RECOMMENDED WATTAGE!

7. Install the glass accessories. (See Figure 03)
8. Restore power to the circuit breaker or fuse box.

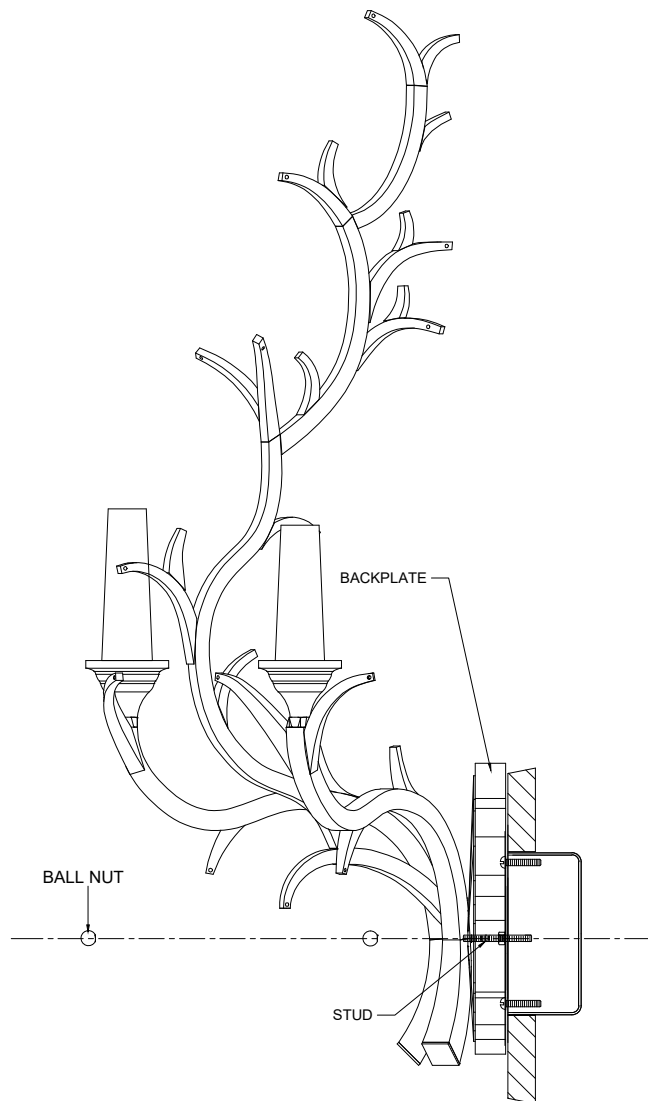



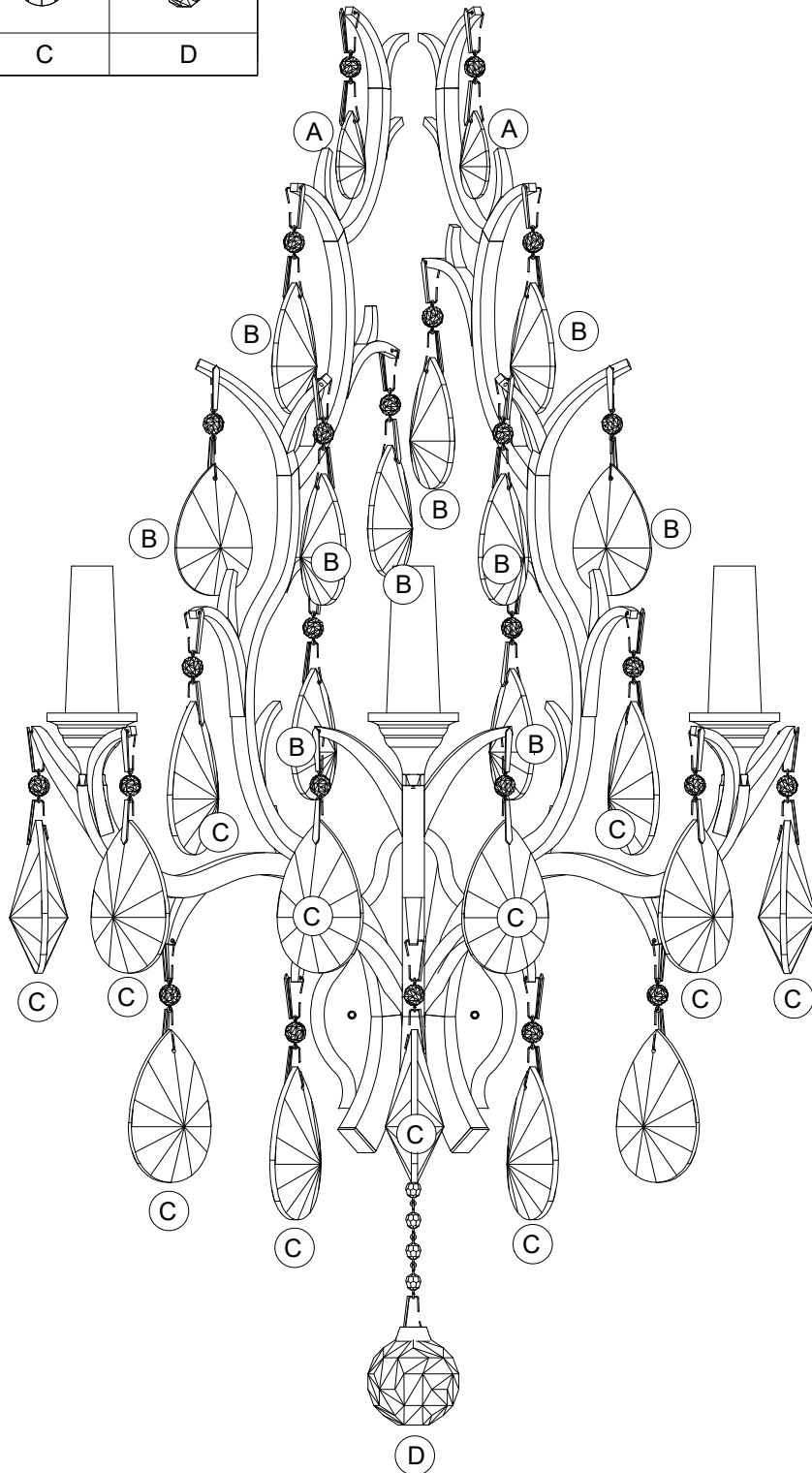

FIGURE-02

AMADEUS XL SCONCE

CRYSTAL SCHEDULES

LEGEND			
2 PCS.	10 PCS.	13 PCS.	1 PC.
			
A	B	C	D



ITEM NUMBER	PART NUMBER	DESCRIPTION
1	R-JW82-HRD	MOUNTING HARDWARE
2	R-JW82-CAC	CANDLE COVER
3	R-JW82-BKP	BACK PLATE
4	R-JW82-FRM	FRAME

