

 **WARNING**

**DISCONNECT POWER BEFORE RELAMPING OR WIRING THE FIXTURE
READ ALL INSTRUCTIONS COMPLETELY BEFORE STARTING INSTALLATION.**

 **CAUTION**

- TO AVOID THE RISK OF FIRE OR SHOCK, FIXTURE MUST BE INSTALLED IN COMPLIANCE WITH ALL APPLICABLE NATIONAL AND LOCAL ELECTRICAL/BUILDING CODES.
- INSTALLATION AND MAINTENANCE OF THIS UNIT REQUIRES AN ELECTRICIAN OR CERTIFIED FACTORY TRAINED TECHNICIAN.
- If an existing fixture is being replaced, remove it and note to which of the wires in the outlet box the fixture was attached. DO NOT SEPARATE ANY OTHER WIRES THAT MAY BE IN THE BOX. DO NOT DAMAGE THE INSULATION OF OLDER WIRING. In regular circumstances the BLACK wire will be the "Hot" lead and the WHITE wire will be the "Neutral" or "Common" lead A GREEN or BARE COPPER wire is the "Ground". In older buildings it is always good practice to reconfirm the polarity of the wiring.

NOTICE

- The important safeguards and instructions outlined on this sheet cannot cover all possible conditions and situations that may occur. It must be understood that common sense, caution and care factors that cannot be built into any product. Caution and care must be supplied by the person(s) installing, operating and caring of this lighting fixture.
- This fixture is design to be mounted on a correctly installed standard round or octagon box or a through wiring box with a plaster frame. The box must be securely mounted to the structure of the building. The crossbar and hardware supplied should be used. Directly mounting the fixture to the outlet box may make it impossible to correctly align the fixture.

FIXTURE PREPARATION

1. Remove the fixture, shades, crystals and parts bag(s) from the carton.

NOTICE:

Before discarding the carton, double check to make certain that all parts are found .

2. Fasten the 4 suspension rods into the canopy .

FIXTURE INSTALLATION

1. Thread the 2 long studs into the adjustable crossbar at the same spacing as the holes in the canopy. (The green screw is in the front). Attach the crossbar to the outlet box. (The green screw should face the floor). Adjust the studs so that they extend 1/4" beyond the canopy.
2. Fasten the bare ground wire to the green or bare copper wire in the outlet box (if outlet box is plastic) or to the green screw on the crossbar.
3. Fasten the white fixture lead to the white wire in the outlet box. Fasten the wires together with an approved fastener (wire nut). Starting about 1" below the fastener, tightly wrap the connection with electrical tape so that the connections seals the end of the fastener.

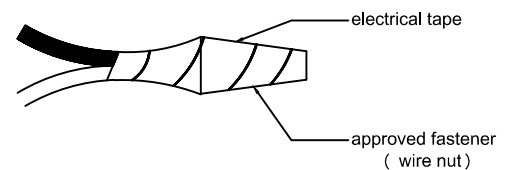
 **WARNING**

Never fasten the ground wire to the black or "hot" wire, and make sure that there is no exposed wire or strands that could cause a dangerous short circuit! Failure to follow these instructions could result in serious injury or death!

4. Connect the black fixture lead to the black wire in the outlet box. Fasten the joined wires as in step 3.
5. Using the end balls, loosely fasten the fixture to the outlet box. Adjust the orientation of the fixture and tighten the end balls.
6. Install the lamps (G9 light bulbs). NOTE: This fixture is rated for 50 watt G9 lamp.

 **WARNING**
DO NOT EXCEED RECOMMENDED WATTAGE!

7. Hang the decorative net to the suspension rods. Install the labeled crystals to the designated chains.
Remove tag once through. Attach decorative chain to the suspension rods.

NOTICE:
**If the fixture is being installed in a room with a hard floor (tile, wood, etc.),
place a blanket or carpet below the fixture before installing the crystals.**



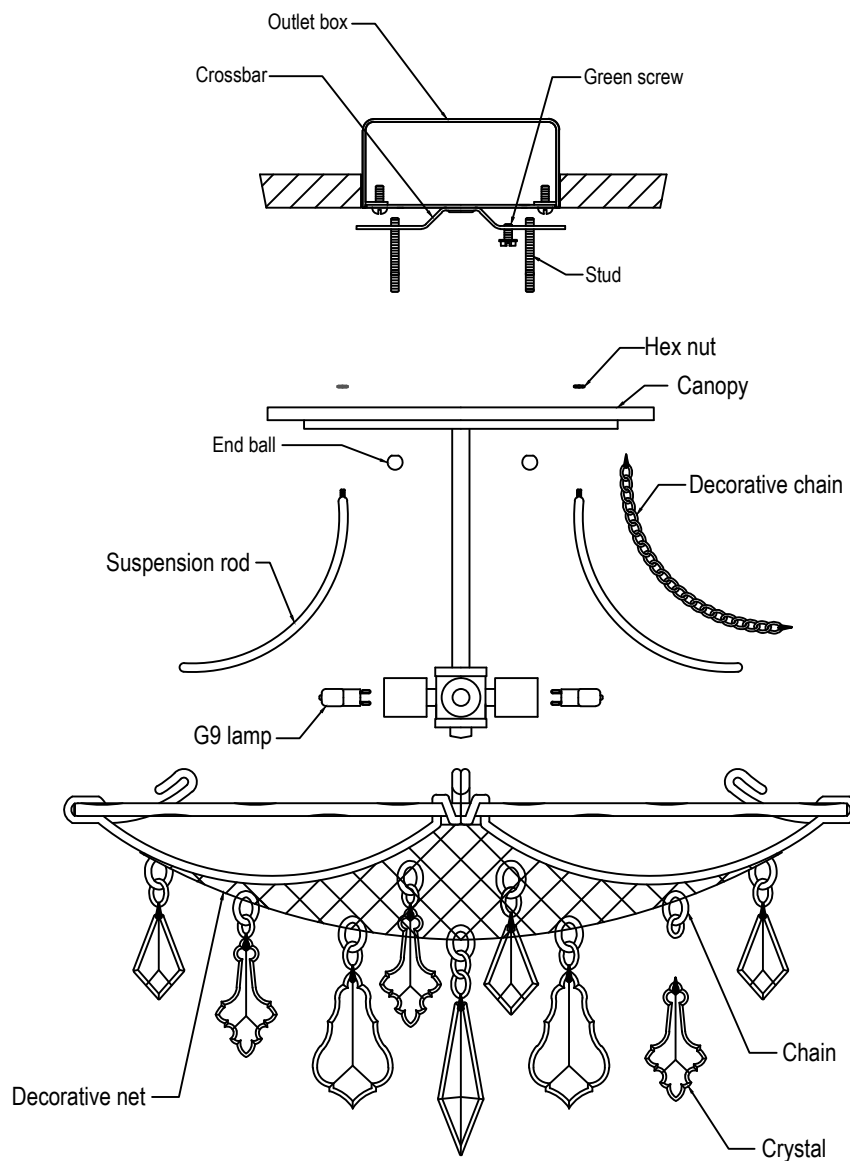



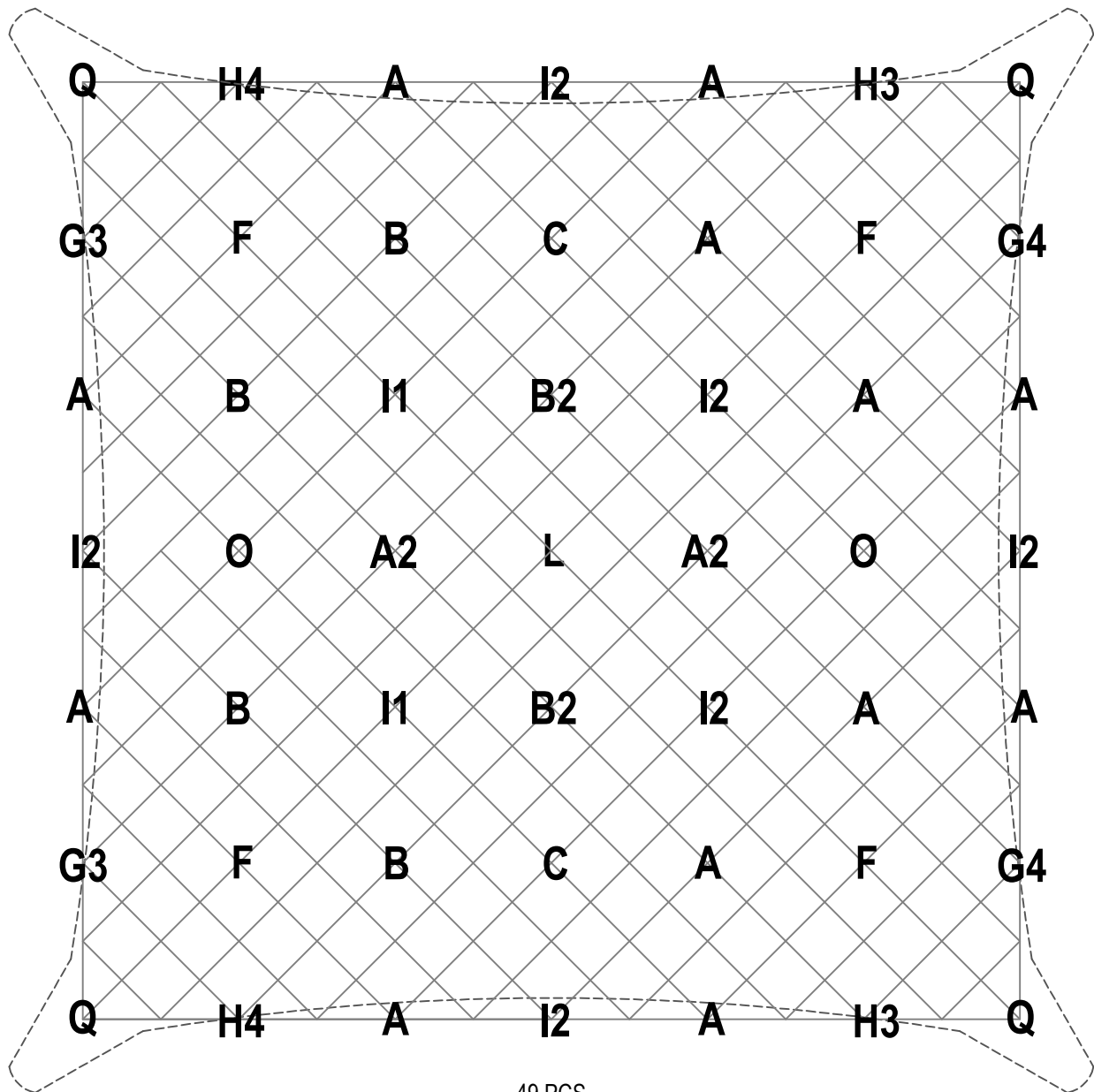



8. Restore power to circuit at breaker or fuse box.







CRYSTAL SCHEDULE

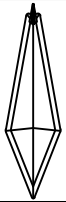

49 PCS.

A	A2	B	B2	F	G3	G4	H3	H4	I1	I2
										
12 PCS.	2 PCS.	4 PCS.	2 PCS.	4 PCS.	2 PCS.	2 PCS.	2 PCS.	2 PCS.	2 PCS.	6 PCS.

Q	O	L	C
			
4 PCS.	2 PCS.	1 PC.	2 PCS.